

ARRONE

The Complete Range



Welcome to HOPPE (UK) Ltd

Founded in 1988 HOPPE (UK) Ltd is now recognised as a market leader in the field of door and window furniture where the HOPPE product is highly respected for both quality and performance.

Following the acquisition of Charter Hardware in 1997 the company has relocated into a new purpose built Distribution Centre at Gailey Park, just seven miles north of Wolverhampton, which is proving an ideal location for distribution throughout the UK whilst still retaining local contact with many of our industries manufacturers who remain based in or around the Midlands area. Our new 50,000 sq ft distribution centre offers ultra-modern facilities for employees, customers and suppliers with a fully equipped showroom/meeting room available.

The publication of this new catalogue allows us to present numerous new products along with existing ranges, many of the products featured are tested to meet the latest European and British standards where applicable, offering quality and innovation to all sectors of the market.

Continuing with the use of state of the art computer technology and equipment coupled with a highly trained and dedicated staff HOPPE (UK) Ltd remains committed to service our customers with pride.

**HOPPE (UK) Ltd are accredited:
Quality Assured EN29002 - ISO 9002 1987**



RS 26824

ARRONE is a registered trade name.

The HOPPE Group Profile

HOPPE – the Company

Founded by Friedrich Hoppe in 1952 in Heiligenhaus near Velbert, the traditional heart of the German architectural hardware industry.

With its headquarters in Mustair, Switzerland HOPPE is today an International company with 3000 employees and 9 factories in Europe and the USA. In addition the company has sales offices in Switzerland, France, the UK and the USA ensuring worldwide distribution for the "handle of excellence".

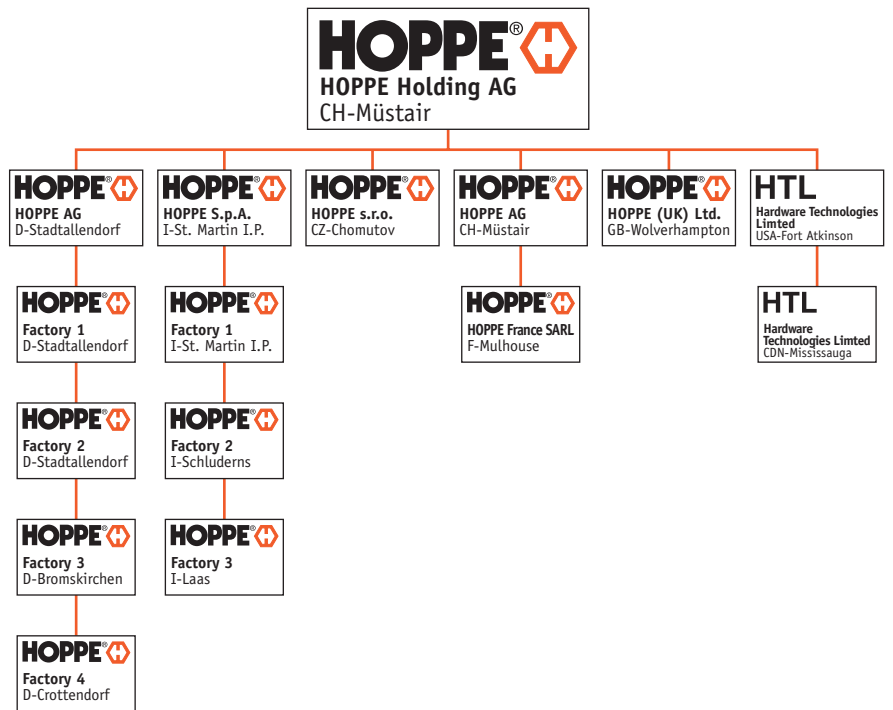

HOPPE is considered to be the brand leader in development, production and distribution of handles for doors and windows in aluminium, brass, nylon and stainless steel.

In fairness to employees, customers, suppliers and the environment, HOPPE pursues the principle of profitability before turnover.

The following beliefs have made the HOPPE - Group what it is today:

"Creativity is intelligent thinking against the norm", the result being "different to and better than others".

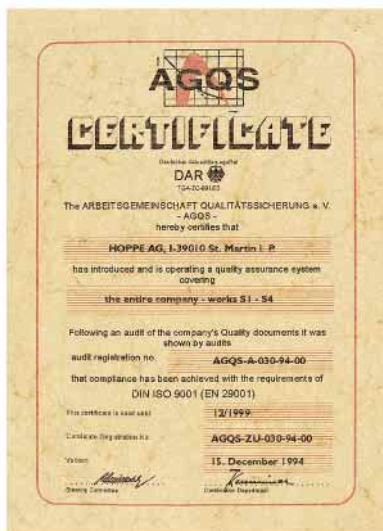



HOPPE – Handle of Excellence

Quality feels good and touching a quality handle conveys the confidence that you have made the right choice. Fittings branded with this logo  are designed to keep the HOPPE promise of quality.

All production plants of the HOPPE - Group in Germany, Italy and the Czech Republic are certified in accordance

with DIN ISO 9001. The continuous striving for the improvement of quality remains a permanent process.

HOPPE is aware that manufacturing a purely faultless product is simply not sufficient today. Economic manufacture to quality standards, performance in accordance with current regulations, short product life cycles and, above all, customer orientation are only some of the important criteria HOPPE is focused on.

HOPPE – the Product Range

For everyone who wants to change their surroundings, HOPPE, Europe's leading brand of door and window handles, can fit in with any personal living and furniture style.

Every original HOPPE product offers high quality at a competitive price. HOPPE products are the tradesman's first choice; there is something for every situation in this extensive product range.

HOPPE not only offers a choice of interestingly designed handles for doors and windows, but also develops specific solutions. Thus a building or an apartment can be equipped from the windows down to the main entrance door with the handle of excellence in aluminium, brass, nylon or stainless steel.

HOPPE – in Harmony with the Environment

Protection of the environment is a basic company belief of constitutional importance. Examples of the active implementations are:

- environment-protective manufacturing
- environment-friendly packaging
- carefully designed measures to lower emission levels below statutory thresholds
- diligent waste water treatment





Contents	Page
Avanté Door Furniture & Closers	4
Architectural Stainless Steel	18
Architectural Nylon	52
Architectural Aluminium	64
Architectural Brass	90
Door Controls :	
Door Closers	108
Floor Springs	120
Electro-Magnetic Door Controls	124
Emergency Exit Hardware :	
ARRONE	130
JPM	138
Architectural Lockcases & Cylinders	142
Hinges	156
Disabled Fittings	162
Premium Aluminium	166
Premium Brassware	172
Premium Lock Collection	178
Fire Signs	184

Materials & Maintenance

Stainless Steel

HOPPE Stainless Steel levers and pull handles are made of chrome nickel steel. Characteristics such as longevity and corrosion resistance, have made stainless steel a popular material in architectural design. Stainless Steel is rustproof because the alloy components of chrome and nickel develop an invisible passive film layer, which also gives excellent resistance to abrasion.

If Stainless Steel fittings do appear to show signs of rust, or greasy and oily soiling, it can be removed with a household detergent which the manufacturer states is suitable for stainless steel.



Nylon

HOPPE Nylon levers and pull handles are manufactured to exacting standards from polyamide nylon. This gives good tensile properties, impact strength and wear resistance. Nylon gives good antistatic behaviour and resistance to corrosion and chemicals. Soiling can be removed with water and/or propriety detergents.



Aluminium

HOPPE Aluminium levers and pull handles are produced using high quality, corrosion resistant alloys. The surface finish of HOPPE aluminium products is by anodising, which gives certain protection against atmospheric corrosion, perspiration from hands, and light scratching.

Aluminium does not need special care because the oxide film protects the surface. Dirt spots can be removed with a soft cloth and water.



Brass

HOPPE Brass fittings are produced using high quality brass. Lever furniture is laquered using the electro-phoretic process, providing an excellent resistance to solvents and chemicals. Nonetheless, the use of aggressive cleaning agents should be avoided. Damage to the surface by mechanical action (e.g. by keys) can also cause corrosion. No special care is needed in everyday use; however any dirt can be removed with a soft cloth and water.

Tip: HOPPE brass pull handles are waxed and not lacquered. Therefore a natural patina (darkened brass) does develop after a while. Should this be undesirable the handles can be periodically polished.



Split Profile Spindle

HOPPE have developed a new patented profile spindle which for the first time features a method of fitting and securing the inside lever handle onto the door. Supplied in 8mm only, the spindle is compatible with most of the popular locks currently manufactured.

Having determined the correct position of the lever handle a special bulb shaped screw is tightened into the neck of the handle by means of an allen key.

The screw enters the spindle and forces it to separate and form a close fit against the lock follower, providing a very secure position.

Due to the design of the spindle, the screw cannot become loose through vibration or the continuous opening and closing of the door. In the event of the handle needing to be adjusted, this is easily solved by removing the screw with the allen key and relocating it.

- The spindle is very easily introduced into the lever

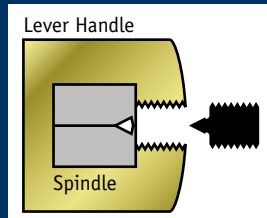

- With the first turn of the allen key the special screw enters the spindle, keeping the handle in the correct position

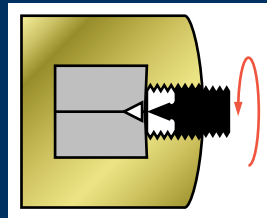

- The bulb-shaped screw point forces the spindle to separate and form a very tight fit against the lock follower and the lever handle

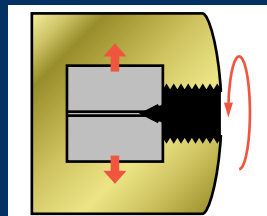

Full Profile Spindle

HOPPE Full Profile Spindles have a tension spring running the full length of the spindle.

In screwing the lever handle grub screw into the slots in the middle of the spring, the tension spring expands achieving a secure fix to the lock follower.

- When spindle is pushed into neck of lever

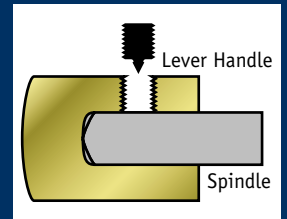

- Introduce grub screw into hole
- The grub screw point must locate into the slot in the spindle where it will bore a hole

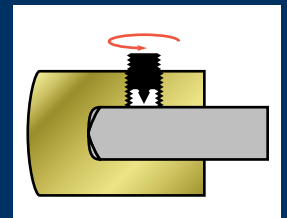

- Once fitted correctly this will achieve solid fixing

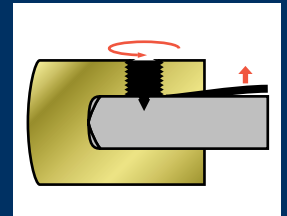

All sizes shown in this catalogue are in millimetres (unless otherwise stated).

Finishes

Abbreviation	Full Description	Abbreviation	Full Description
BL	Black	PC	Powder Coated White
BLK	Black	PC-B	Prime Coat Beige
BR	Brass Plated	PSS	Polished Stainless Steel
CH	Chrome	SAA	Satin Anodised Aluminium
CPG	Champagne	SB	Satin Brass
EPS	Epoxy Powder Coated Silver	SC	Satin Chrome
NP	Nickel Plated	SE	Silver Enamel
PB	Polished Brass	SS	Satin Stainless Steel
		SSS	Satin Stainless Steel

Standards and Approvals

Many of the products featured in this catalogue have been tested by recognised independent testing organisations to ensure they meet the requirements of the latest standards and regulations required in today's market place.

Where applicable test reports and/or certificates are available upon request.

BS EN	The new British/European performance and safety standards.
B.S.I.	British Standards Institute
CERTIFIRE	Fire Testing
U.L.	Underwriters Laboratories of America Incorporated
A.N.S.I.	American Standards Institute Specification
D.I.N.	German Performance Standards
PSA/MOB	Property Services Agency. PSA MOB H3 PS July 1989.

ARRONE
is a registered trade name

Every effort has been made to ensure that at the time of going to press all the information contained in this catalogue is correct, however we reserve the right to make modifications in the interest of progress.



Avanté
Avanté
Avanté
Avanté
Avanté

Avanté

Tomorrow's Styling : Delivered Today

Avanté

The latest innovation from **HOPPE (UK) Ltd.** offers the opportunity to combine the utmost in Door Closer and Door Furniture technology with new designs and finishes.

Avanté enables you to combine and suite together the most modern designed single and dual finish door furniture with a new British designed and manufactured Door Closer range.





Avanté joins together two of Europe's leading manufacturers; **HOPPE** Europe's market leading manufacturer of Door and Window Furniture with **JEBRON** recognised as one of the UK's leading Door Closer manufacturers. Both companies are respected internationally for the quality of their products, competitiveness within their markets and innovation.

Avanté is the latest and ultimate solution to all of your Door Furniture and Door Closer requirements.

Avanté - Tomorrow's Styling : Delivered Today

Tomorrow's Styling : Delivered Today

Maintaining our position as Europe's leading manufacturer of Door and Window Fittings remains a difficult task. Trends change and consumers continue to demand new products at even more competitive prices, often quality is sacrificed to meet these demands.

Not so in this case, accepting the challenge **HOPPE**  have introduced the Avanté Series of Door Furniture. Consisting of three very different new designs, available in both solid or a combination of finishes and manufactured to the highest technological engineering standards, using only top quality materials whilst retaining the competitive edge the **HOPPE**  name is renowned for.

Exclusively styled and designed by **HOPPE**  in Italy using the latest computerised CAD-CAM design systems all three patterns have been styled to meet the latest European trends, combining elegance with style and durability.

Manufactured by **HOPPE**  Stadtallendorf factory in Germany using only the highest quality material and technological engineering standards Avanté Series Door Furniture will enhance many prestigious applications.

Avanté's range of combination finishes coupled with three modern designs and the quality renowned **HOPPE**  manufacturing process ensure you offer your customer the quality demanded.

In addition Avanté allows you the opportunity to combine Door Furniture and Closers to create your own individual suite.





Athina i Series

AVANTI

Athinai

Three words describe **Athinai** - modern, sleek and elegant, **Athinai** will enhance many applications both domestic and commercial. Using Brass as a base material and finish the designers have combined the trend towards Stainless Steel to create this aesthetically pleasing handle.



Lever Handles : Sprung : Bolt Fixing

AR-M156/19-PC-SSS

Lever on rose : polished chrome & satin stainless steel

AR-M156/19-PB-PC

Lever on rose : polished brass & polished chrome

AR-M156/19-PB

Lever on rose : polished brass

Escutcheons :

Polished Chrome

Satin Stainless Steel

Polished Brass

AR-M19S-36-PC

Lever key escutcheon

AR-M19S-36-SSS

Lever key escutcheon

AR-M19S-36-PB

Lever key escutcheon

AR-M19S-37-PC

Euro profile escutcheon

AR-M19S-37-SSS

Euro profile escutcheon

AR-M19S-37-PB

Euro profile escutcheon

AR-M19S-38-PC

Oval profile escutcheon

AR-M19S-38-SSS

Oval profile escutcheon

AR-M19S-38-PB

Oval profile escutcheon



Venezia Series

Avanté

A simple clean design **Venezia** combines elegance with durability. The use of the Polished Stainless Steel inset adds the touch of class not often found in today's market.

Venezia



Lever Handles : Sprung : Bolt Fixing

AR-M132/42-PB

Lever on rose : polished brass

AR-M132/42-PB-PC

Lever on rose : polished brass & polished chrome

Escutcheons :

Polished Brass

AR490/36

Lever key escutcheon

AR490/37

Euro profile escutcheon

AR490/38

Oval profile escutcheon

Capri Series



Capri

Offering a conventional Round Bar furniture, with a modern combination of finishes. Using Brass as the base material, Capri lever furniture is an ideal choice for many prestigious applications.



Lever Handles : Sprung : Bolt Fixing

AR-M1950/15-PC-SSS

Lever on rose : polished chrome & satin stainless steel

AR-M1950/15-PB-PC

Lever on rose : polished brass & polished chrome

AR-M1950/15-SB-SSS

Lever on rose : satin brass & satin stainless steel

Escutcheons

Polished Chrome

AR-E15S-36-PC

Lever key escutcheon

AR-E15S-37-PC

Euro profile escutcheon

AR-E15S-38-PC

Oval profile escutcheon

Satin Stainless Steel

AR-E15S-36-SSS

Lever key escutcheon

AR-E15S-37-SSS

Euro profile escutcheon

AR-E15S-38-SSS

Oval profile escutcheon



The **Avanté Door Closers Series** combines the latest innovation in cover design, styling and finish whilst retaining the build quality and performance which has resulted in all models being successfully type tested to the latest European Standards BS EN1154/1155. The flexibility of **Avanté** allows you to create your own aesthetically pleasing door closer to match your choice of furniture by following a specification selection process based on each of the following:-

- The unit to suit the required application
- The finish of the cover
- The finish of the end caps
- The finish of the arm

Your **Avanté Door Closer** will then be supplied from our distribution centre complete with all fitting instructions.

Manufactured in England by **Jebron**, an ISO 9000 registered company, using the latest technological engineering methods, the **Avanté Door Closer Series** introduces innovation to the door closer market at affordable prices.

British Design

British Engineering

British Manufacture

Tomorrow's Styling • Delivered Today

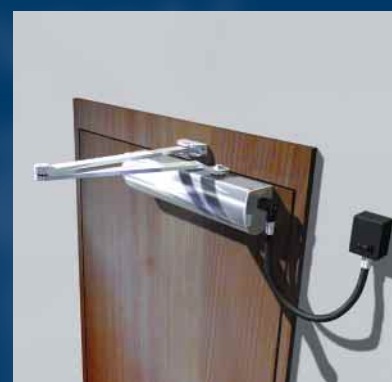

Both Avanté door closer units feature a revolutionary cam and roller mechanism which guarantees a smooth opening action for easy access, coupled with the correct holding force to maintain the door in the closed position. This revolutionary mechanism creates high efficiency durability and long life.

One & Two



AVANTÉ ONE

Standard unit. Size selectable 3 - 4 by template

AVANTÉ TWO

Variable power unit. Size adjustable 2 ~ 5 with backcheck

Standard Features:

- British made to exacting engineering standards by **Jebbron**, an ISO9000 company
- Extruded aluminium body
- Cam and roller mechanism
- Universal application
- Fixed arm
- Adjustable latch action
- Adjustable closing speed
- Aluminium slide cover and end caps

Options:

- **Avanté 1** Backcheck
- **Avanté 2** Delayed action
- **Avanté 1 & 2** Adjustable arm
Hold open arm
Coloured and plated arm

Applications:

Commercial or industrial applications.

Fire Rating:

Certifire approved for use on 30 mins, 1 hr and 2 hr fire doors.

Standards:

Avanté Door Closer has been successfully type tested for conformity to all the requirements of BS EN1154. Test reports and/or certificates are available upon request.

Finish:

- Silver (with silver or black arm supplied as standard)
- Polished Brass (with black arm supplied as standard)
- Polished and Satin Anodised Aluminium
- Polished and Satin Stainless Steel
- RAL Colours

Guarantee:

The mechanism is guaranteed for 10 years against all faults in manufacture or material in the UK, Isle of Man and Channel Islands. This warranty is subject to the appropriate size and model of door closer being used, fixed, adjusted and maintained in accordance with the manufacturers recommendations.

Three

This innovative cam roller mechanism is designed to exclusively operate a door closer where slide arm fitting is required, whilst retaining closing and holding forces with a smooth operating action and no power loss. Slide arm door closers are now enjoying a larger share of the market because of their pleasing aesthetics and safety features.



AVANTÉ THREE

Slide arm door closer. Adjustable power size 2 ~ 4



Standard Features:

- British made to exacting engineering standards by **Jebron**, an ISO9000 company
- Extruded aluminium body
- Cam and roller mechanism
- Slide arm application
- Adjustable latch action
- Adjustable closing speed
- Aluminium slide cover and end caps

Options:

- Backcheck (in track)

Applications:

Commercial or industrial applications

Fire Rating:

Certifire approved for use on 30 mins, 1 hr and 2 hr fire doors.

Standards:

Avanté Door Closer has been successfully type tested for conformity to all the requirements of BS EN1154. Test reports and/or certificates are available upon request.

Finish:

- Silver (with silver or black arm supplied as standard)
- Polished Brass (with black arm supplied as standard)
- Polished and Satin Anodised Aluminium
- Polished and Satin Stainless Steel
- RAL Colours

Guarantee:

The mechanism is guaranteed for 10 years against all faults in manufacture or material in the UK, Isle of Man and Channel Islands. This warranty is subject to the appropriate size and model of door closer being used, fixed, adjusted and maintained in accordance with the manufacturers recommendations.

Completing the Avanté door control range the electro magnetic unit retains the same aesthetics and finish flexibility. The unit is manufactured to the highest engineering standards and offers site selection of hold open or swing free applications.

Four



AVANTÉ FOUR

Electro magnetic door closer. Size selectable 3 - 4 by template



Standard Features:

- British made to exacting engineering standards by **Jebron**, an ISO9000 company
- Extruded aluminium body
- Cam and roller mechanism
- Universal application
- Adjustable arm
- Adjustable latch action
- Adjustable closing speed
- Aluminium slide cover and end caps
- Site selectable hold open - swing free
- Supplied with armoured loop and test switch terminal box for testing purposes
- Voltage 24 volts DC.

Applications:

Commercial or industrial applications.

Fire Rating:

Certifire approved for use on 30 mins, 1 hr and 2 hr fire doors.

Standards:

Avanté Door Closer has been successfully type tested for conformity to all the requirements of BS EN1155. Test reports and/or certificates are available upon request.

Finish:

- Silver (with silver or black arm supplied as standard)
- Polished Brass (with black arm supplied as standard)
- Polished and Satin Anodised Aluminium
- Polished and Satin Stainless Steel
- RAL Colours

Guarantee:

The mechanism is guaranteed for 10 years against all faults in manufacture or material in the UK, Isle of Man and Channel Islands. This warranty is subject to the appropriate size and model of door closer being used, fixed, adjusted and maintained in accordance with the manufacturers recommendations.

Architectural **Stainless Steel**

Architectural Stainless Steel

HOPPE Stainless Steel levers and pull handles are manufactured from chrome nickel steel. Characteristics such as longevity and corrosion resistance, have made stainless steel a popular material in architectural design. Stainless Steel is rust resistant because the alloy components of chrome and nickel develop an invisible passive film layer, which also gives excellent resistance to abrasion.

If Stainless Steel fittings do appear to show signs of rust, or greasy and oily soiling, it can be removed with a household detergent which the manufacturer states is suitable for stainless steel.

Manufactured by **HOPPE** in Germany this range of architectural door furniture offers five elegant designs of levers and a range of pull handles in both satin and polished finishes.

Levers on round rose are available either sprung or unsprung. The sprung levers are supplied with a solid 8mm spindle which has a tension spring ensuring a close fit between the lock follower and spindle after installation.

Levers on backplate are unsprung and are supplied with the **HOPPE** patented profile 8mm spindle, a proven system for providing a secure fixing to the door.

Pull handles are available in concealed screw fix, bolt fix or back to back fixing. Consideration should be given to the use of the handle, and bolt fix or back to back fix should be specified in high use situations.

HOPPE stainless steel levers and pull handles are ideal for use in public buildings, offices, hospitals, and hotels, which are used by large numbers of people.

HOPPE stainless steel levers conform to German DIN standard 18255.

HOPPE stainless steel furniture combines elegance with durability.



Verona Series

Verona Series

Levers on Round Rose - Steel Underplate (sprung)

- Heavy duty springing
- Laser welding on neck of lever for heavy duty operation
- Bolt through fixing with 5mm bolt giving stronger, more secure fixing alleviating the need for grub screw into lever neck
- Over 90 degree full operation of lever, which can take up any "play" in oversized lock follower

AR360/10SPSS	20mm sprung lever on rose, 130mm full profile spindle Steel understructure, 2 point fixing, 36mm to 50mm door thickness	SSS
AR360/10SPSS	20mm sprung lever on rose, 130mm full profile spindle Steel understructure, 2 point fixing, 36mm to 50mm door thickness	PSS

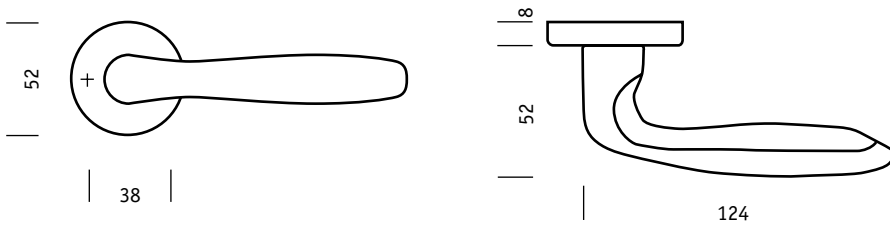

Concealed Fix Escutcheons

- Supplied with nylon understructure
- Steel understructure available for concealed fix escutcheons to special order

AR300/26SS	Lever key escutcheon 52mm diameter, 38mm fixing centres	SSS
AR300/26PSS	Lever key escutcheon 52mm diameter, 38mm fixing centres	PSS
AR300/27SS	Euro profile escutcheon 52mm diameter, 38mm fixing centres	SSS
AR300/27PSS	Euro profile escutcheon 52mm diameter, 38mm fixing centres	PSS
AR300/28SS	Oval profile escutcheon 52mm diameter, 38mm fixing centres	SSS
AR300/28PSS	Oval profile escutcheon 52mm diameter, 38mm fixing centres	PSS

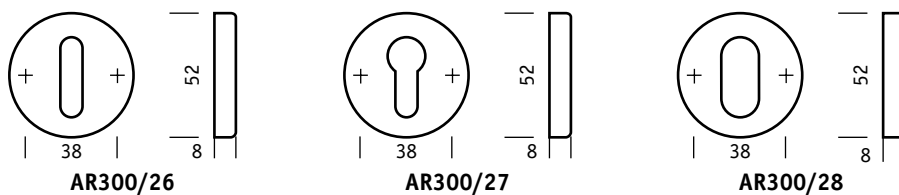

Turn & Indicator

AR300/29SS	Bathroom turn & indicator, 5mm spindle 52mm diameter, 38mm fixing centres	SSS
AR300/29PSS	Bathroom turn & indicator, 5mm spindle 52mm diameter, 38mm fixing centres	PSS
AR300/29-DSS	Disabled turn & indicator, 5mm spindle 52mm diameter, 38mm fixing centres	SSS
AR300/29D-PSS	Disabled turn & indicator, 5mm spindle 52mm diameter, 38mm fixing centres	PSS

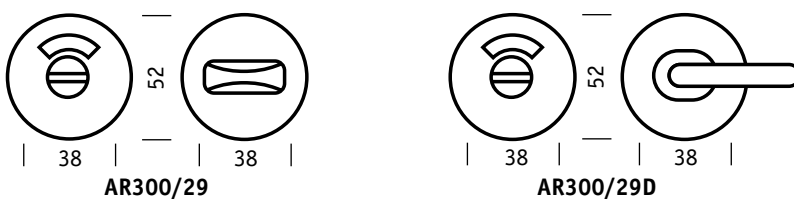

ARCHITECTURAL STAINLESS STEEL

Levers on Round Rose - Nylon Underplate (sprung)

AR360/10NY-SP-SS	20mm sprung lever on rose, 100mm split profile spindle Nylon understructure, 36mm to 50mm door thickness	SSS
-------------------------	---	------------

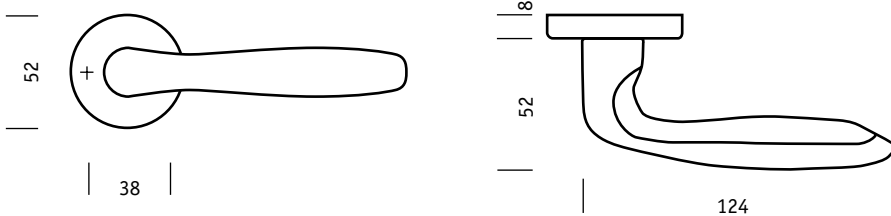

Levers on Round Rose - Nylon Underplate (unsprung)

AR360/10SS	20mm unsprung lever on rose, 110mm split profile spindle Nylon understructure, 36mm to 50mm door thickness	SSS
AR360/10PSS	20mm unsprung lever on rose, 110mm split profile spindle Nylon understructure, 36mm to 50mm door thickness	PSS

Concealed Fix Escutcheons

AR300/26SS	Lever key escutcheon 52mm diameter, 38mm fixing centres	SSS
AR300/26PSS	Lever key escutcheon 52mm diameter, 38mm fixing centres	PSS
AR300/27SS	Euro profile escutcheon 52mm diameter, 38mm fixing centres	SSS
AR300/27PSS	Euro profile escutcheon 52mm diameter, 38mm fixing centres	PSS
AR300/28SS	Oval profile escutcheon 52mm diameter, 38mm fixing centres	SSS
AR300/28PSS	Oval profile escutcheon 52mm diameter, 38mm fixing centres	PSS

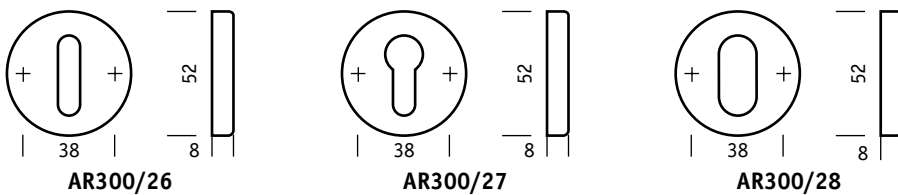

ARCHITECTURAL STAINLESS STEEL

Turn & Indicator

AR300/29SS	Bathroom turn & indicator, 5mm spindle 52mm diameter, 38mm fixing centres	SSS
AR300/29PSS	Bathroom turn & indicator, 5mm spindle 52mm diameter, 38mm fixing centres	PSS
AR300/29D-SS	Disabled turn & indicator, 5mm spindle 52mm diameter, 38mm fixing centres	SSS
AR300/29D-PSS	Disabled turn & indicator, 5mm spindle 52mm diameter, 38mm fixing centres	PSS

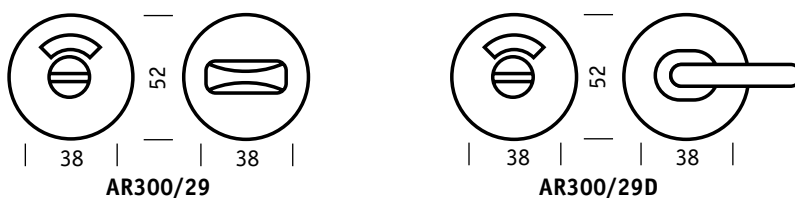

Verona Series

Levers on Concealed Fix Oblong Plate (unsprung)

- 130mm split profile spindle
- Suitable for 36mm to 50mm door thickness
- Bolt through fixing with 5mm bolt giving stronger, more secure fixing alleviating the need for grub screw into lever neck
- AR360/13 also available with 72mm centres

AR360/11SS	Long plate latch furniture	SSS
AR360/11PSS	Long plate latch furniture	PSS
AR360/12SS	Lock furniture	SSS
AR360/12PSS	Lock furniture	PSS
AR360/13SS	Euro profile lock furniture	SSS
AR360/13PSS	Euro profile lock furniture	PSS
AR360/14SS	Oval profile lock furniture	SSS
AR360/14PSS	Oval profile lock furniture	PSS
AR360/15SS	Bathroom furniture	SSS
AR360/15PSS	Bathroom furniture	PSS

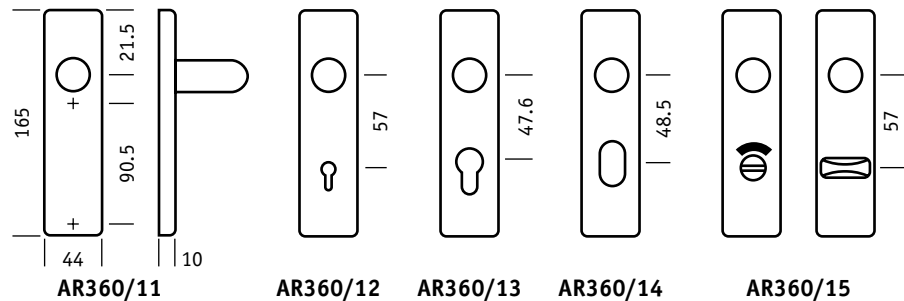

Levers on Concealed Fix Radius Plate (unsprung)

- 130mm split profile spindle
- Suitable for 36mm to 50mm door thickness
- Bolt through fixing with 5mm bolt giving stronger, more secure fixing alleviating the need for grub screw into lever neck
- AR360/33 also available with 72mm centres

AR360/31SS	Long plate latch furniture	SSS
AR360/31PSS	Long plate latch furniture	PSS
AR360/32SS	Lock furniture	SSS
AR360/32PSS	Lock furniture	PSS
AR360/33SS	Euro profile lock furniture	SSS
AR360/33PSS	Euro profile lock furniture	PSS
AR360/34SS	Oval profile lock furniture	SSS
AR360/34PSS	Oval profile lock furniture	PSS
AR360/35SS	Bathroom furniture	SSS
AR360/35PSS	Bathroom furniture	PSS

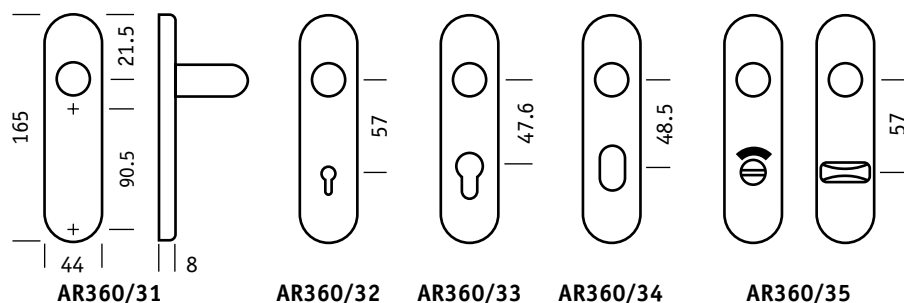



Paris Series

Paris Series

Levers on Round Rose - Steel Underplate (sprung) : $\varnothing 20\text{mm}$

- Heavy duty springing
- Laser welding on neck of lever for heavy duty operation
- Bolt through fixing with 5mm bolt giving stronger, more secure fixing alleviating the need for grub screw into lever neck
- Over 90 degree full operation of lever, which can take up any "play" in oversized lock follower

AR300/10SPSS	20mm sprung lever on rose, 130mm full profile spindle Steel understructure, 2 point fixing, 36mm to 50mm door thickness	SSS
AR300/10SPSS	20mm sprung lever on rose, 130mm full profile spindle Steel understructure, 2 point fixing, 36mm to 50mm door thickness	PSS

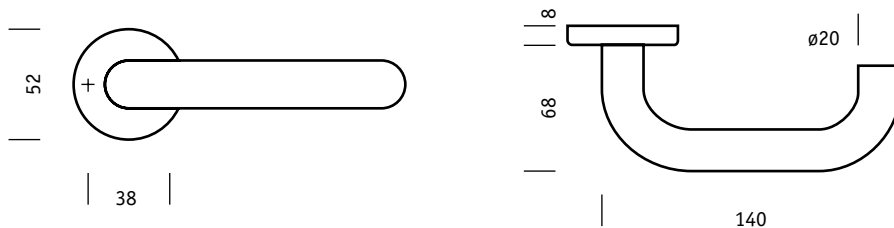

Concealed Fix Escutcheons

- Supplied with nylon understructure
- Steel understructure available for concealed fix escutcheons to special order

AR300/26SS	Lever key escutcheon 52mm diameter, 38mm fixing centres	SSS
AR300/26PSS	Lever key escutcheon 52mm diameter, 38mm fixing centres	PSS
AR300/27SS	Euro profile escutcheon 52mm diameter, 38mm fixing centres	SSS
AR300/27PSS	Euro profile escutcheon 52mm diameter, 38mm fixing centres	PSS
AR300/28SS	Oval profile escutcheon 52mm diameter, 38mm fixing centres	SSS
AR300/28PSS	Oval profile escutcheon 52mm diameter, 38mm fixing centres	PSS

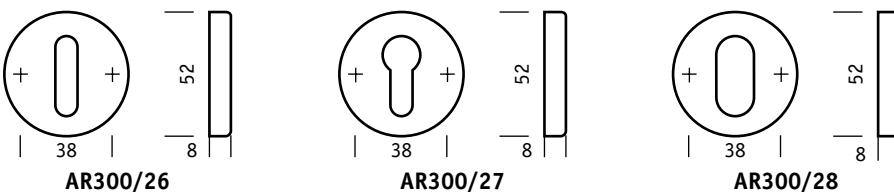

Turn & Indicator

AR300/29SS	Bathroom turn & indicator, 5mm spindle 52mm diameter, 38mm fixing centres	SSS
AR300/29PSS	Bathroom turn & indicator, 5mm spindle 52mm diameter, 38mm fixing centres	PSS
AR300/29D-SS	Disabled turn & indicator, 5mm spindle 52mm diameter, 38mm fixing centres	SSS
AR300/29D-PSS	Disabled turn & indicator, 5mm spindle 52mm diameter, 38mm fixing centres	PSS

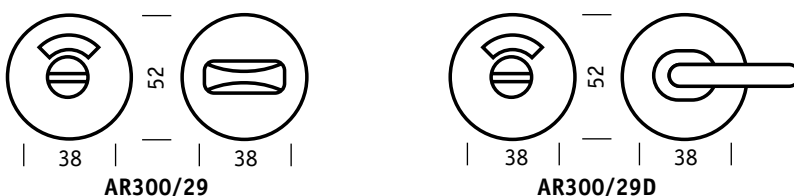

Levers on Round Rose - Nylon Underplate (sprung) : ø20mm

AR300/10NY-SP-SS	20mm sprung lever on rose, 100mm split profile spindle Nylon understructure, 36mm to 50mm door thickness	SSS
AR300/10NY-SP-PSS	20mm sprung lever on rose, 100mm split profile spindle Nylon understructure, 36mm to 50mm door thickness	PSS

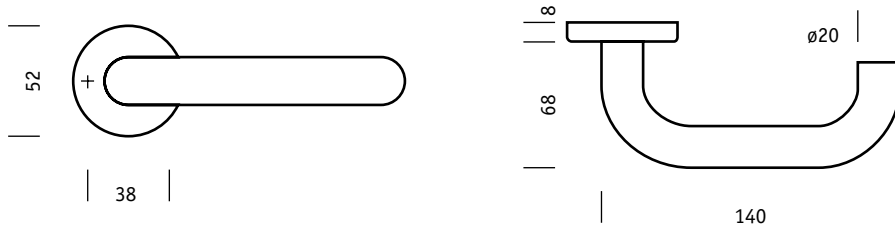

Levers on Round Rose - Nylon Underplate (unsprung) : ø20mm

AR300/10SS	20mm unsprung lever on rose, 110mm split profile spindle Nylon understructure, 36mm to 50mm door thickness	SSS
AR300/10PSS	20mm unsprung lever on rose, 110mm split profile spindle Nylon understructure, 36mm to 50mm door thickness	PSS

Concealed Fix Escutcheons

AR300/26SS	Lever key escutcheon 52mm diameter, 38mm fixing centres	SSS
AR300/26PSS	Lever key escutcheon 52mm diameter, 38mm fixing centres	PSS
AR300/27SS	Euro profile escutcheon 52mm diameter, 38mm fixing centres	SSS
AR300/27PSS	Euro profile escutcheon 52mm diameter, 38mm fixing centres	PSS
AR300/28SS	Oval profile escutcheon 52mm diameter, 38mm fixing centres	SSS
AR300/28PSS	Oval profile escutcheon 52mm diameter, 38mm fixing centres	PSS

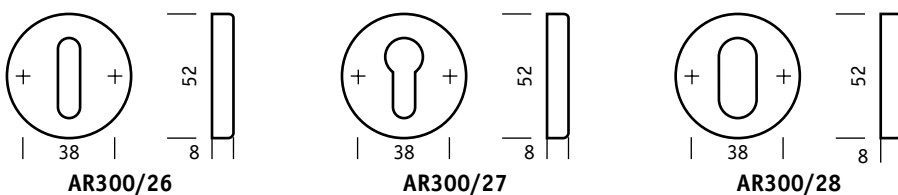

Turn & Indicator

AR300/29SS	Bathroom turn & indicator, 5mm spindle 52mm diameter, 38mm fixing centres	SSS
AR300/29PSS	Bathroom turn & indicator, 5mm spindle 52mm diameter, 38mm fixing centres	PSS
AR300/29D-SS	Disabled turn & indicator, 5mm spindle 52mm diameter, 38mm fixing centres	SSS
AR300/29D-PSS	Disabled turn & indicator, 5mm spindle 52mm diameter, 38mm fixing centres	PSS

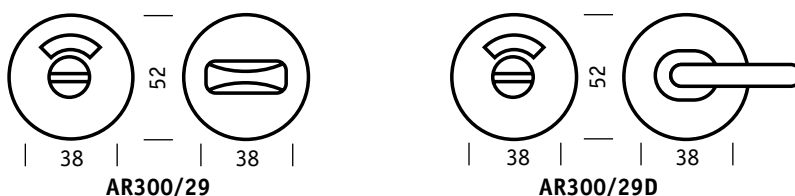

Paris Series

Levers on Concealed Fix Oblong Plate (unsprung) : ø20mm

- 130mm split profile spindle
- Suitable for 36mm to 50mm door thickness
- Bolt through fixing with 5mm bolt giving stronger, more secure fixing alleviating the need for grub screw into lever neck
- AR300/13 also available with 72mm centres

AR300/11SS	Long plate latch furniture	SSS
AR300/11PSS	Long plate latch furniture	PSS
AR300/12SS	Lock furniture	SSS
AR300/12PSS	Lock furniture	PSS
AR300/13SS	Euro profile lock furniture	SSS
AR300/13PSS	Euro profile lock furniture	PSS
AR300/14SS	Oval profile lock furniture	SSS
AR300/14PSS	Oval profile lock furniture	PSS
AR300/15SS	Bathroom furniture	SSS
AR300/15PSS	Bathroom furniture	PSS

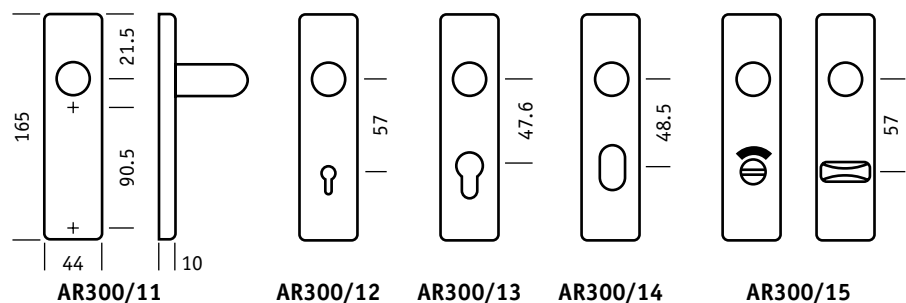

Levers on Concealed Fix Radius Plate (unsprung) : ø20mm

- 130mm split profile spindle
- Suitable for 36mm to 50mm door thickness
- Bolt through fixing with 5mm bolt giving stronger, more secure fixing alleviating the need for grub screw into lever neck
- AR300/33 also available with 72mm centres

AR300/31SS	Long plate latch furniture	SSS
AR300/31PSS	Long plate latch furniture	PSS
AR300/32SS	Lock furniture	SSS
AR300/32PSS	Lock furniture	PSS
AR300/33SS	Euro profile lock furniture	SSS
AR300/33PSS	Euro profile lock furniture	PSS
AR300/34SS	Oval profile lock furniture	SSS
AR300/34PSS	Oval profile lock furniture	PSS
AR300/35SS	Bathroom furniture	SSS
AR300/35PSS	Bathroom furniture	PSS

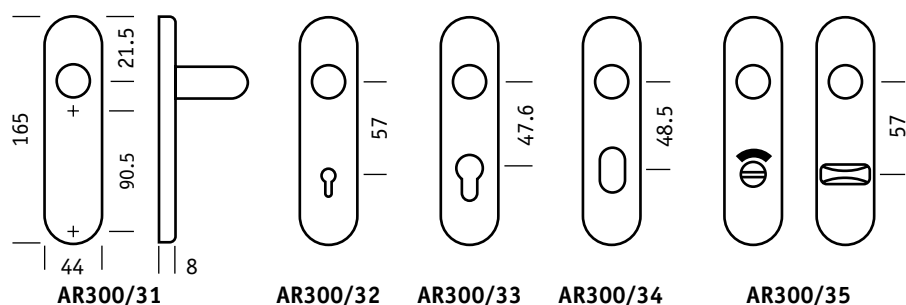



Bonn Series

Bonn Series

Levers on Round Rose - Steel Underplate (sprung) : $\varnothing 20\text{mm}$

- Heavy duty springing
- Laser welding on neck of lever for heavy duty operation
- Bolt through fixing with 5mm bolt giving stronger, more secure fixing alleviating the need for grub screw into lever neck
- Over 90 degree full operation of lever, which can take up any "play" in oversized lock follower

AR330/10SPSS	20mm sprung lever on rose, 130mm full profile spindle Steel understructure, 2 point fixing, 36mm to 50mm door thickness	SSS
AR330/10PPSS	20mm sprung lever on rose, 130mm full profile spindle Steel understructure, 2 point fixing, 36mm to 50mm door thickness	PSS

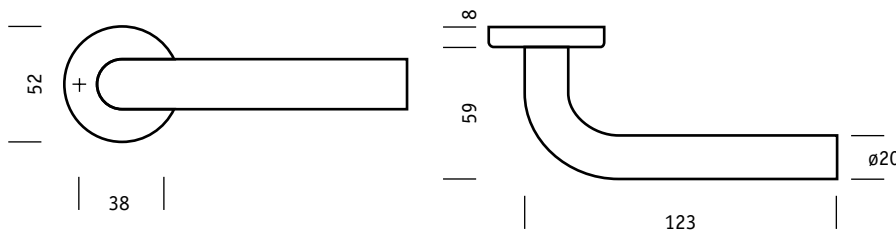

Concealed Fix Escutcheons

- Supplied with nylon understructure
- Steel understructure available for concealed fix escutcheons to special order

AR300/26SS	Lever key escutcheon 52mm diameter, 38mm fixing centres	SSS
AR300/26PSS	Lever key escutcheon 52mm diameter, 38mm fixing centres	PSS
AR300/27SS	Euro profile escutcheon 52mm diameter, 38mm fixing centres	SSS
AR300/27PSS	Euro profile escutcheon 52mm diameter, 38mm fixing centres	PSS
AR300/28SS	Oval profile escutcheon 52mm diameter, 38mm fixing centres	SSS
AR300/28PSS	Oval profile escutcheon 52mm diameter, 38mm fixing centres	PSS

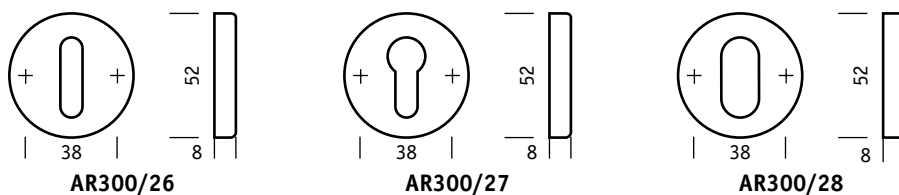

Turn & Indicator

AR300/29SS	Bathroom turn & indicator, 5mm spindle 52mm diameter, 38mm fixing centres	SSS
AR300/29PSS	Bathroom turn & indicator, 5mm spindle 52mm diameter, 38mm fixing centres	PSS
AR300/29D-SS	Disabled turn & indicator, 5mm spindle 52mm diameter, 38mm fixing centres	SSS
AR300/29D-PSS	Disabled turn & indicator, 5mm spindle 52mm diameter, 38mm fixing centres	PSS

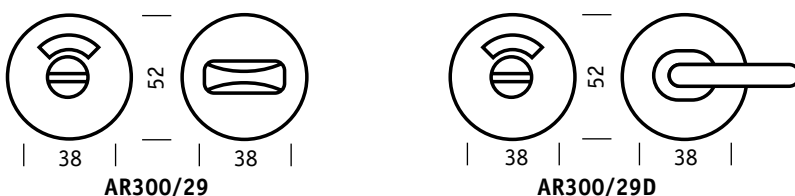

Levers on Round Rose - Nylon Underplate (sprung) : ø20mm

AR330/10NY-SP-SS	20mm sprung lever on rose, 100mm split profile spindle Nylon understructure, 36mm to 50mm door thickness	SSS
-------------------------	---	------------

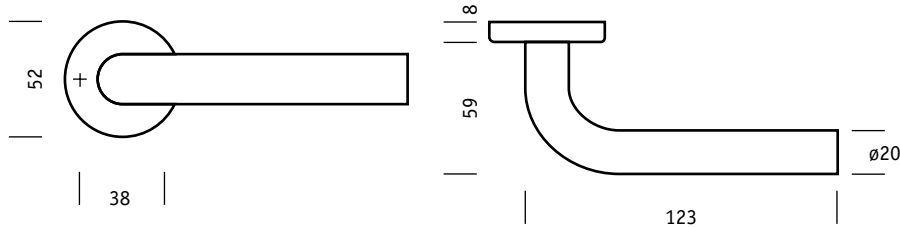

Levers on Round Rose - Nylon Underplate (unsprung) : ø20mm

AR330/10SS	20mm unsprung lever on rose, 110mm split profile spindle Nylon understructure, 36mm to 50mm door thickness	SSS
-------------------	---	------------

AR330/10PSS	20mm unsprung lever on rose, 110mm split profile spindle Nylon understructure, 36mm to 50mm door thickness	PSS
--------------------	---	------------

Concealed Fix Escutcheons

AR300/26SS	Lever key escutcheon 52mm diameter, 38mm fixing centres	SSS
AR300/26PSS	Lever key escutcheon 52mm diameter, 38mm fixing centres	PSS
AR300/27SS	Euro profile escutcheon 52mm diameter, 38mm fixing centres	SSS
AR300/27PSS	Euro profile escutcheon 52mm diameter, 38mm fixing centres	PSS
AR300/28SS	Oval profile escutcheon 52mm diameter, 38mm fixing centres	SSS
AR300/28PSS	Oval profile escutcheon 52mm diameter, 38mm fixing centres	PSS

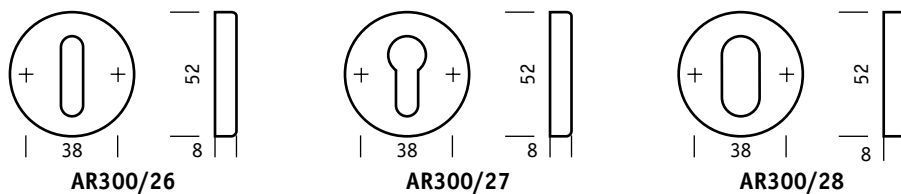

Turn & Indicator

AR300/29SS	Bathroom turn & indicator, 5mm spindle 52mm diameter, 38mm fixing centres	SSS
-------------------	--	------------

AR300/29PSS	Bathroom turn & indicator, 5mm spindle 52mm diameter, 38mm fixing centres	PSS
--------------------	--	------------

AR300/29D-SS	Disabled turn & indicator, 5mm spindle 52mm diameter, 38mm fixing centres	SSS
---------------------	--	------------

AR300/29D-PSS	Disabled turn & indicator, 5mm spindle 52mm diameter, 38mm fixing centres	PSS
----------------------	--	------------

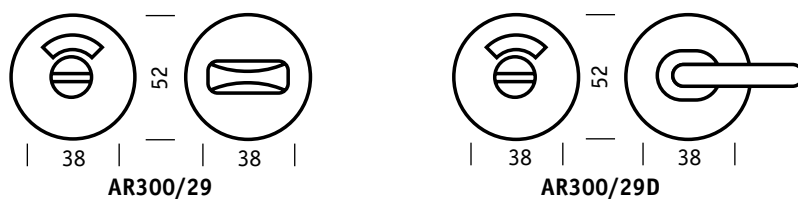

Bonn Series

Levers on Concealed Fix Oblong Plate (unsprung) : $\varnothing 20\text{mm}$

- 130mm split profile spindle
- Suitable for 36mm to 50mm door thickness
- Bolt through fixing with 5mm bolt giving stronger, more secure fixing alleviating the need for grub screw into lever neck
- AR330/13 also available with 72mm centres

AR330/11SS	Long plate latch furniture	SSS
AR330/11PSS	Long plate latch furniture	PSS
AR330/12SS	Lock furniture	SSS
AR330/12PSS	Lock furniture	PSS
AR330/13SS	Euro profile lock furniture	SSS
AR330/13PSS	Euro profile lock furniture	PSS
AR330/14SS	Oval profile lock furniture	SSS
AR330/14PSS	Oval profile lock furniture	PSS
AR330/15SS	Bathroom furniture	SSS
AR330/15PSS	Bathroom furniture	PSS

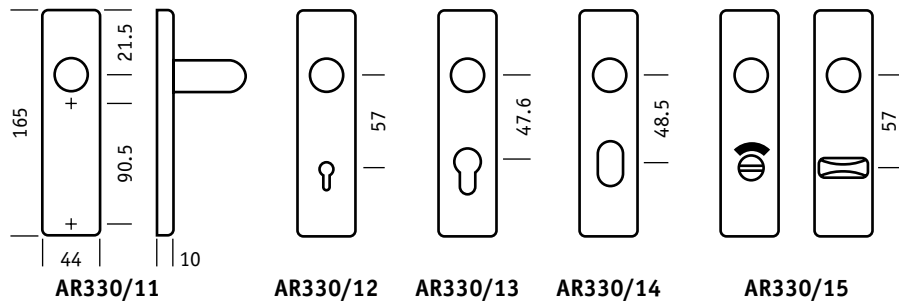

Levers on Concealed Fix Radius Plate (unsprung) : $\varnothing 20\text{mm}$

- 130mm split profile spindle
- Suitable for 36mm to 50mm door thickness
- Bolt through fixing with 5mm bolt giving stronger, more secure fixing alleviating the need for grub screw into lever neck
- AR330/33 also available with 72mm centres

AR330/31SS	Long plate latch furniture	SSS
AR330/31PSS	Long plate latch furniture	PSS
AR330/32SS	Lock furniture	SSS
AR330/32PSS	Lock furniture	PSS
AR330/33SS	Euro profile lock furniture	SSS
AR330/33PSS	Euro profile lock furniture	PSS
AR330/34SS	Oval profile lock furniture	SSS
AR330/34PSS	Oval profile lock furniture	PSS
AR330/35SS	Bathroom furniture	SSS
AR330/35PSS	Bathroom furniture	PSS

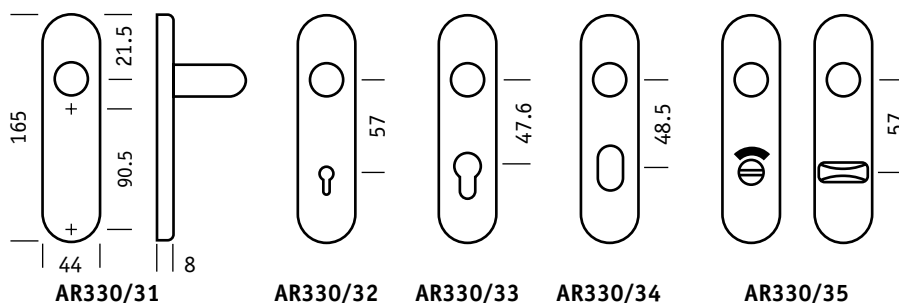



Amsterdam Series

Amsterdam Series

Levers on Round Rose - Steel Underplate (sprung) : $\varnothing 20\text{mm}$

- Heavy duty springing
- Laser welding on neck of lever for heavy duty operation
- Bolt through fixing with 5mm bolt giving stronger, more secure fixing alleviating the need for grub screw into lever neck
- Over 90 degree full operation of lever, which can take up any "play" in oversized lock follower

AR350/10SPSS	20mm sprung lever on rose, 130mm full profile spindle Steel understructure, 2 point fixing, 36mm to 50mm door thickness	SSS
AR350/10PPSS	20mm sprung lever on rose, 130mm full profile spindle Steel understructure, 2 point fixing, 36mm to 50mm door thickness	PSS

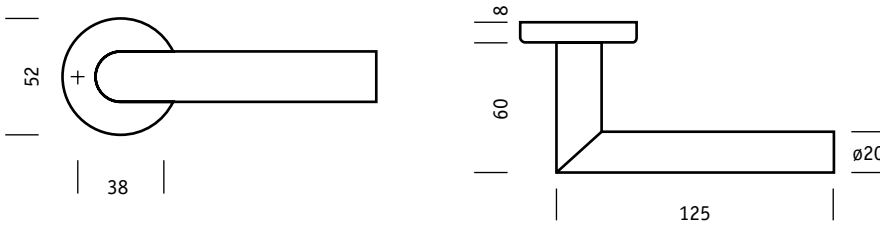

Concealed Fix Escutcheons

- Supplied with nylon understructure
- Steel understructure available for concealed fix escutcheons to special order

AR300/26SS	Lever key escutcheon 52mm diameter, 38mm fixing centres	SSS
AR300/26PSS	Lever key escutcheon 52mm diameter, 38mm fixing centres	PSS
AR300/27SS	Euro profile escutcheon 52mm diameter, 38mm fixing centres	SSS
AR300/27PSS	Euro profile escutcheon 52mm diameter, 38mm fixing centres	PSS
AR300/28SS	Oval profile escutcheon 52mm diameter, 38mm fixing centres	SSS
AR300/28PSS	Oval profile escutcheon 52mm diameter, 38mm fixing centres	PSS

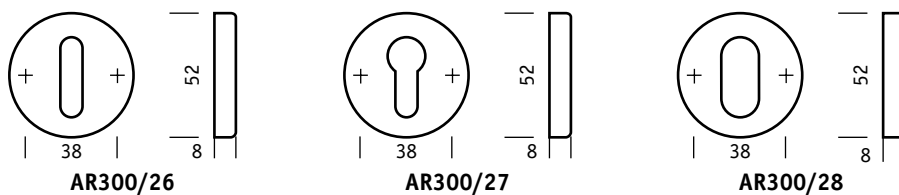

Turn & Indicator

AR300/29SS	Bathroom turn & indicator, 5mm spindle 52mm diameter, 38mm fixing centres	SSS
AR300/29PSS	Bathroom turn & indicator, 5mm spindle 52mm diameter, 38mm fixing centres	PSS
AR300/29D-SS	Disabled turn & indicator, 5mm spindle 52mm diameter, 38mm fixing centres	SSS
AR300/29D-PSS	Disabled turn & indicator, 5mm spindle 52mm diameter, 38mm fixing centres	PSS

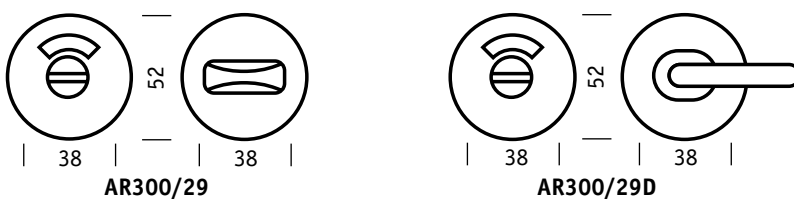

Levers on Round Rose - Nylon Underplate (sprung) : $\varnothing 20\text{mm}$

AR350/10NY-SP-SS	20mm sprung lever on rose, 100mm split profile spindle Nylon understructure, 36mm to 50mm door thickness	SSS
-------------------------	---	------------

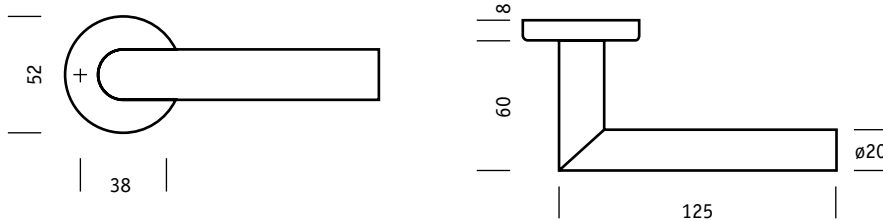

Levers on Round Rose - Nylon Underplate (unsprung) : $\varnothing 20\text{mm}$

AR350/10SS	20mm unsprung lever on rose, 110mm split profile spindle Nylon understructure, 36mm to 50mm door thickness	SSS
-------------------	---	------------

AR350/10PSS	20mm unsprung lever on rose, 110mm split profile spindle Nylon understructure, 36mm to 50mm door thickness	PSS
--------------------	---	------------

Concealed Fix Escutcheons

AR300/26SS	Lever key escutcheon 52mm diameter, 38mm fixing centres	SSS
AR300/26PSS	Lever key escutcheon 52mm diameter, 38mm fixing centres	PSS
AR300/27SS	Euro profile escutcheon 52mm diameter, 38mm fixing centres	SSS
AR300/27PSS	Euro profile escutcheon 52mm diameter, 38mm fixing centres	PSS
AR300/28SS	Oval profile escutcheon 52mm diameter, 38mm fixing centres	SSS
AR300/28PSS	Oval profile escutcheon 52mm diameter, 38mm fixing centres	PSS

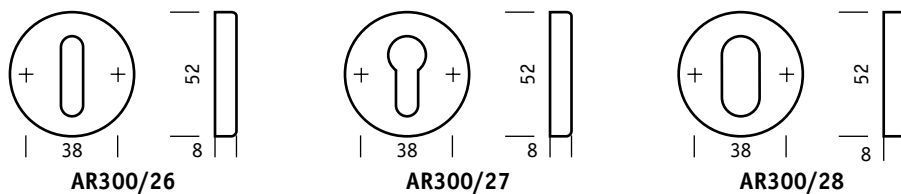

Turn & Indicator

AR300/29SS	Bathroom turn & indicator, 5mm spindle 52mm diameter, 38mm fixing centres	SSS
-------------------	--	------------

AR300/29PSS	Bathroom turn & indicator, 5mm spindle 52mm diameter, 38mm fixing centres	PSS
--------------------	--	------------

AR300/29D-SS	Disabled turn & indicator, 5mm spindle 52mm diameter, 38mm fixing centres	SSS
---------------------	--	------------

AR300/29D-PSS	Disabled turn & indicator, 5mm spindle 52mm diameter, 38mm fixing centres	PSS
----------------------	--	------------

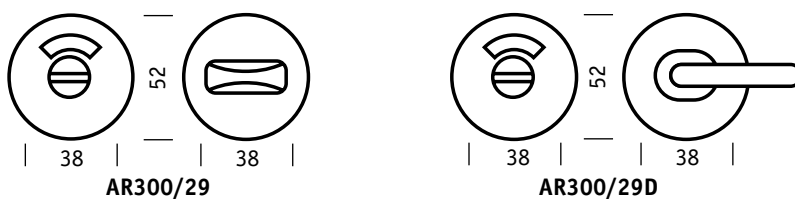

Amsterdam Series

Levers on Concealed Fix Oblong Plate (unsprung) : $\varnothing 20\text{mm}$

- 130mm split profile spindle
- Suitable for 36mm to 50mm door thickness
- Bolt through fixing with 5mm bolt giving stronger, more secure fixing alleviating the need for grub screw into lever neck
- AR350/13 also available with 72mm centres

AR350/11SS	Long plate latch furniture	SSS
AR350/11PSS	Long plate latch furniture	PSS
AR350/12SS	Lock furniture	SSS
AR350/12PSS	Lock furniture	PSS
AR350/13SS	Euro profile lock furniture	SSS
AR350/13PSS	Euro profile lock furniture	PSS
AR350/14SS	Oval profile lock furniture	SSS
AR350/14PSS	Oval profile lock furniture	PSS
AR350/15SS	Bathroom furniture	SSS
AR350/15PSS	Bathroom furniture	PSS

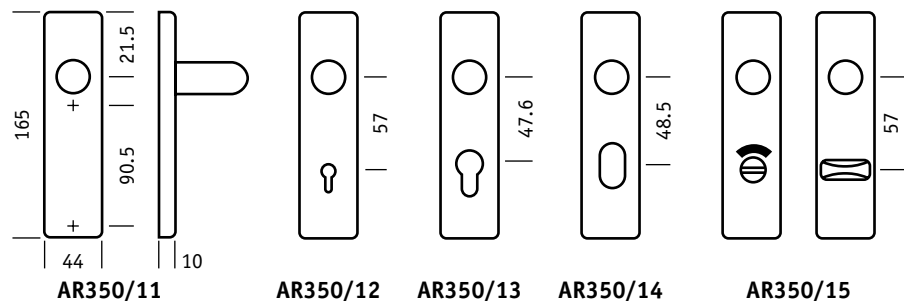

Levers on Concealed Fix Radius Plate (unsprung) : $\varnothing 20\text{mm}$

- 130mm split profile spindle
- Suitable for 36mm to 50mm door thickness
- Bolt through fixing with 5mm bolt giving stronger, more secure fixing alleviating the need for grub screw into lever neck
- AR350/33 also available with 72mm centres

AR350/31SS	Long plate latch furniture	SSS
AR350/31PSS	Long plate latch furniture	PSS
AR350/32SS	Lock furniture	SSS
AR350/32PSS	Lock furniture	PSS
AR350/33SS	Euro profile lock furniture	SSS
AR350/33PSS	Euro profile lock furniture	PSS
AR350/34SS	Oval profile lock furniture	SSS
AR350/34PSS	Oval profile lock furniture	PSS
AR350/35SS	Bathroom furniture	SSS
AR350/35PSS	Bathroom furniture	PSS

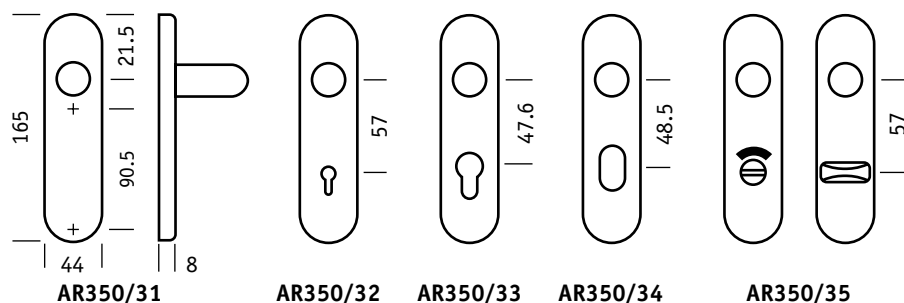



San Francisco Series

San Francisco Series

Levers on Round Rose - Steel Underplate (sprung)

- Heavy duty springing
- Laser welding on neck of lever for heavy duty operation
- Bolt through fixing with 5mm bolt giving stronger, more secure fixing alleviating the need for grub screw into lever neck
- Over 90 degree full operation of lever, which can take up any "play" in oversized lock follower

AR310/10SPSS	20mm sprung lever on rose, 130mm full profile spindle Steel understructure, 2 point fixing, 36mm to 50mm door thickness	SSS
AR310/10SPSS	20mm sprung lever on rose, 130mm full profile spindle Steel understructure, 2 point fixing, 36mm to 50mm door thickness	PSS

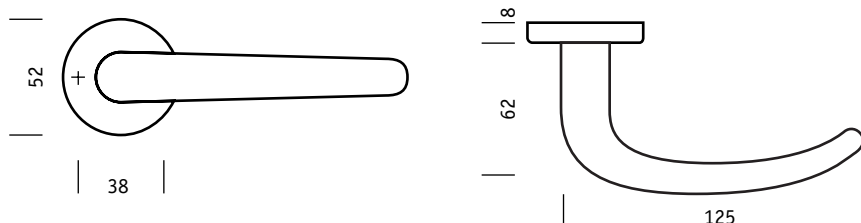

Concealed Fix Escutcheons

- Supplied with nylon understructure
- Steel understructure available for concealed fix escutcheons to special order

AR300/26SS	Lever key escutcheon 52mm diameter, 38mm fixing centres	SSS
AR300/26PSS	Lever key escutcheon 52mm diameter, 38mm fixing centres	PSS
AR300/27SS	Euro profile escutcheon 52mm diameter, 38mm fixing centres	SSS
AR300/27PSS	Euro profile escutcheon 52mm diameter, 38mm fixing centres	PSS
AR300/28SS	Oval profile escutcheon 52mm diameter, 38mm fixing centres	SSS
AR300/28PSS	Oval profile escutcheon 52mm diameter, 38mm fixing centres	PSS

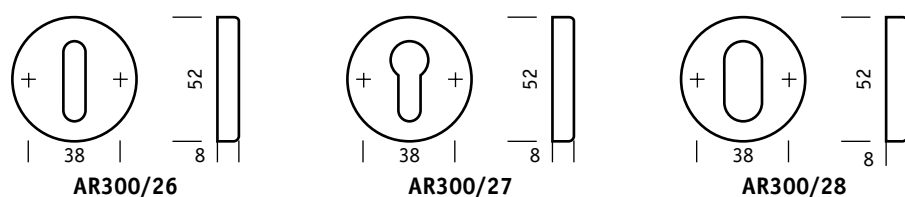

Turn & Indicator

AR300/29SS	Bathroom turn & indicator, 5mm spindle 52mm diameter, 38mm fixing centres	SSS
AR300/29PSS	Bathroom turn & indicator, 5mm spindle 52mm diameter, 38mm fixing centres	PSS
AR300/29D-SS	Disabled turn & indicator, 5mm spindle 52mm diameter, 38mm fixing centres	SSS
AR300/29D-PSS	Disabled turn & indicator, 5mm spindle 52mm diameter, 38mm fixing centres	PSS

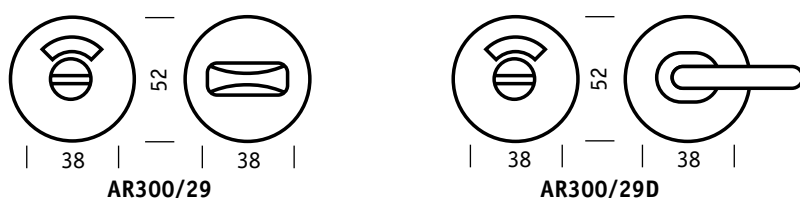

Levers on Round Rose - Nylon Underplate (sprung)

AR310/10NY-SP-SS	20mm sprung lever on rose, 100mm split profile spindle Nylon understructure, 36mm to 50mm door thickness	SSS
-------------------------	---	------------

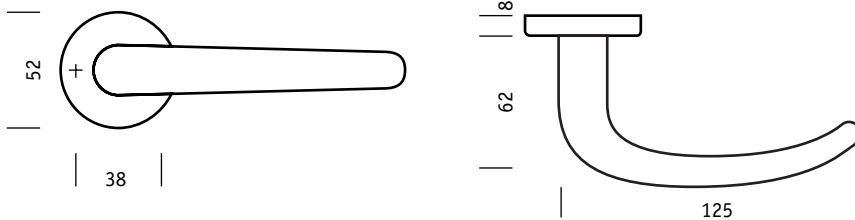

Levers on Round Rose - Nylon Underplate (unsprung)

AR310/10SS	20mm unsprung lever on rose, 110mm split profile spindle Nylon understructure, 36mm to 50mm door thickness	SSS
-------------------	---	------------

AR310/10PSS	20mm unsprung lever on rose, 110mm split profile spindle Nylon understructure, 36mm to 50mm door thickness	PSS
--------------------	---	------------

Concealed Fix Escutcheons

AR300/26SS	Lever key escutcheon 52mm diameter, 38mm fixing centres	SSS
AR300/26PSS	Lever key escutcheon 52mm diameter, 38mm fixing centres	PSS
AR300/27SS	Euro profile escutcheon 52mm diameter, 38mm fixing centres	SSS
AR300/27PSS	Euro profile escutcheon 52mm diameter, 38mm fixing centres	PSS
AR300/28SS	Oval profile escutcheon 52mm diameter, 38mm fixing centres	SSS
AR300/28PSS	Oval profile escutcheon 52mm diameter, 38mm fixing centres	PSS

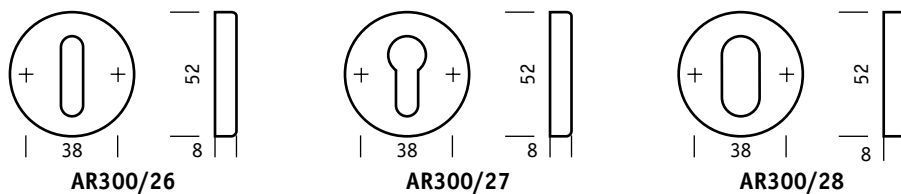

ARCHITECTURAL STAINLESS STEEL

Turn & Indicator

AR300/29SS	Bathroom turn & indicator, 5mm spindle 52mm diameter, 38mm fixing centres	SSS
-------------------	--	------------

AR300/29PSS	Bathroom turn & indicator, 5mm spindle 52mm diameter, 38mm fixing centres	PSS
--------------------	--	------------

AR300/29D-SS	Disabled turn & indicator, 5mm spindle 52mm diameter, 38mm fixing centres	SSS
---------------------	--	------------

AR300/29D-PSS	Disabled turn & indicator, 5mm spindle 52mm diameter, 38mm fixing centres	PSS
----------------------	--	------------

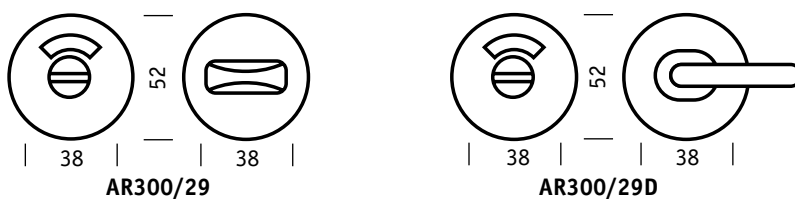

San Francisco Series

Levers on Concealed Fix Oblong Plate (unsprung)

- 130mm split profile spindle
- Suitable for 36mm to 50mm door thickness
- Bolt through fixing with 5mm bolt giving stronger, more secure fixing alleviating the need for grub screw into lever neck
- AR310/13 also available with 72mm centres

AR310/11SS	Long plate latch furniture	SSS
AR310/11PSS	Long plate latch furniture	PSS
AR310/12SS	Lock furniture	SSS
AR310/12PSS	Lock furniture	PSS
AR310/13SS	Euro profile lock furniture	SSS
AR310/13PSS	Euro profile lock furniture	PSS
AR310/14SS	Oval profile lock furniture	SSS
AR310/14PSS	Oval profile lock furniture	PSS
AR310/15SS	Bathroom furniture	SSS
AR310/15PSS	Bathroom furniture	PSS

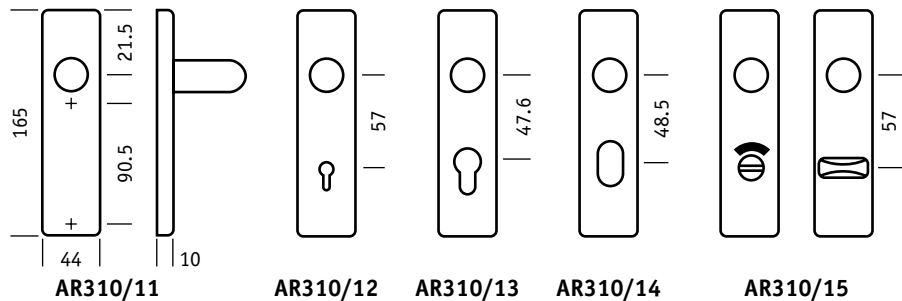

Levers on Concealed Fix Radius Plate (unsprung)

- 130mm split profile spindle
- Suitable for 36mm to 50mm door thickness
- Bolt through fixing with 5mm bolt giving stronger, more secure fixing alleviating the need for grub screw into lever neck
- AR310/33 also available with 72mm centres

AR310/31SS	Long plate latch furniture	SSS
AR310/31PSS	Long plate latch furniture	PSS
AR310/32SS	Lock furniture	SSS
AR310/32PSS	Lock furniture	PSS
AR310/33SS	Euro profile lock furniture	SSS
AR310/33PSS	Euro profile lock furniture	PSS
AR310/34SS	Oval profile lock furniture	SSS
AR310/34PSS	Oval profile lock furniture	PSS
AR310/35SS	Bathroom furniture	SSS
AR310/35PSS	Bathroom furniture	PSS

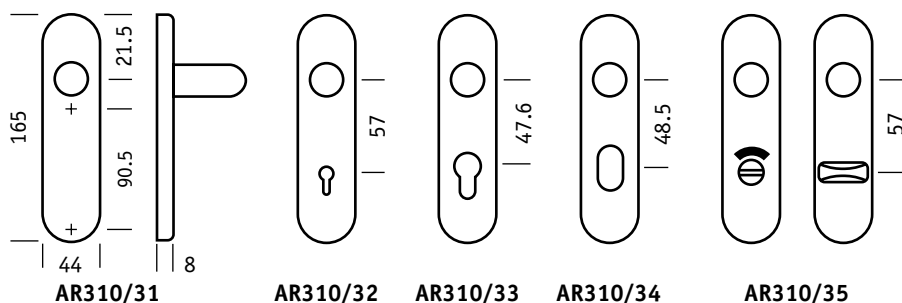



Pull Handles

Pull Handles

Straight Pull Handles : $\varnothing 20\text{mm}$

AR302/20/200CF-SS	200mm concealed screw fixing	SSS
AR302/20/200CF-PSS	200mm concealed screw fixing	PSS
AR302/20/225CF-SS	225mm concealed screw fixing	SSS
AR302/20/225CF-PSS	225mm concealed screw fixing	PSS
AR302/20/300CF-SS	300mm concealed screw fixing	SSS
AR302/20/300CF-PSS	300mm concealed screw fixing	PSS
AR302/20/425CF-SS	425mm concealed screw fixing	SSS
AR302/20/425CF-PSS	425mm concealed screw fixing	PSS
AR302/20/650CF-SS	650mm concealed screw fixing	SSS
AR302/20/650CF-PSS	650mm concealed screw fixing	PSS

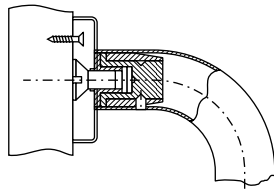
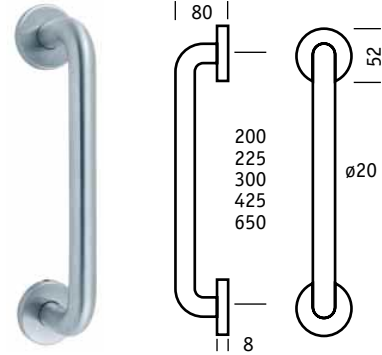

AR303/20/200BF-SS	200mm bolt fixing	SSS
AR303/20/200BF-PSS	200mm bolt fixing	PSS
AR303/20/225BF-SS	225mm bolt fixing	SSS
AR303/20/225BF-PSS	225mm bolt fixing	PSS
AR303/20/300BF-SS	300mm bolt fixing	SSS
AR303/20/300BF-PSS	300mm bolt fixing	PSS
AR303/20/425BF-SS	425mm bolt fixing	SSS
AR303/20/425BF-PSS	425mm bolt fixing	PSS
AR303/20/650BF-SS	650mm bolt fixing	SSS
AR303/20/650BF-PSS	650mm bolt fixing	PSS

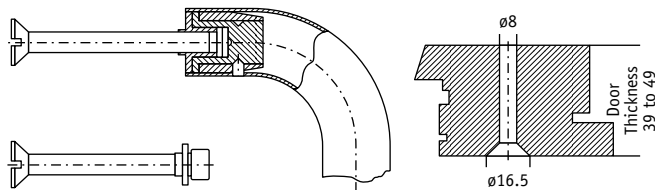
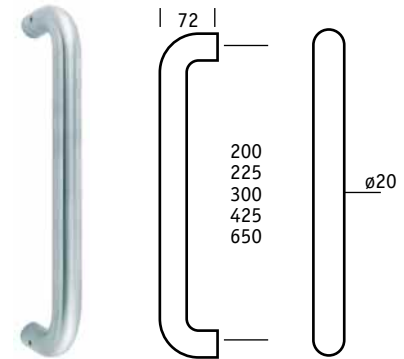

AR304/20/200BB-SS	200mm back to back	SSS
AR304/20/200BB-PSS	200mm back to back	PSS
AR304/20/225BB-SS	225mm back to back	SSS
AR304/20/225BB-PSS	225mm back to back	PSS
AR304/20/300BB-SS	300mm back to back	SSS
AR304/20/300BB-PSS	300mm back to back	PSS
AR304/20/425BB-SS	425mm back to back	SSS
AR304/20/425BB-PSS	425mm back to back	PSS
AR304/20/650BB-SS	650mm back to back	SSS
AR304/20/650BB-PSS	650mm back to back	PSS

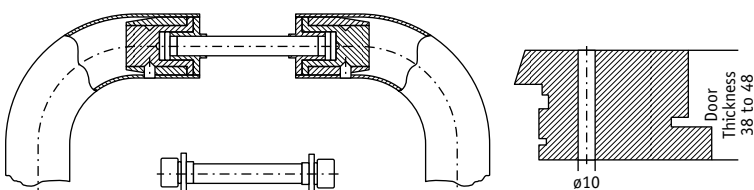
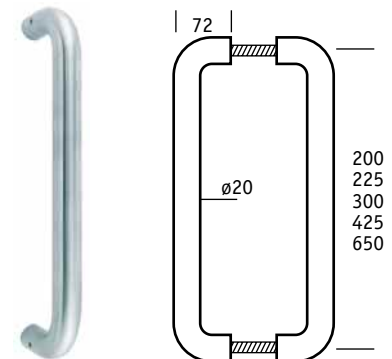

Straight Pull Handles : $\varnothing 25\text{mm}$

AR303/25/300BF-SS	300mm bolt fixing	SSS
AR303/25/300BF-PSS	300mm bolt fixing	PSS
AR303/25/350BF-SS	350mm bolt fixing	SSS
AR303/25/350BF-PSS	350mm bolt fixing	PSS

- Other lengths are available to special order

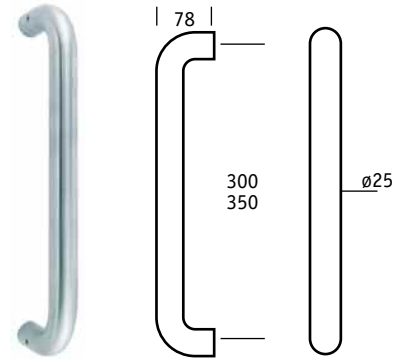
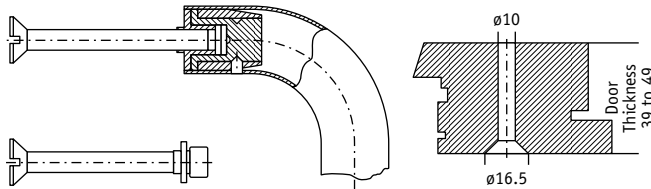

AR304/25/300BB-SS	300mm back to back fixing	SSS
AR304/25/300BB-PSS	300mm back to back fixing	PSS
AR304/25/350BB-SS	350mm back to back fixing	SSS
AR304/25/350BB-PSS	350mm back to back fixing	PSS

- Other lengths are available to special order

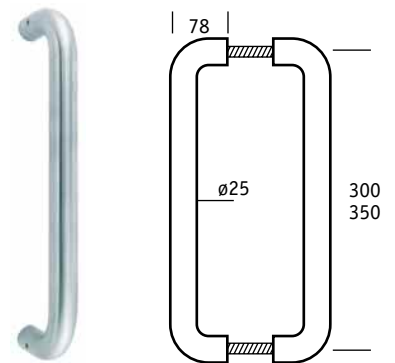
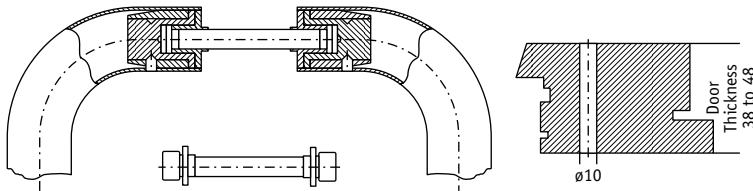

Straight Pull Handles : $\varnothing 30\text{mm}$

AR303/30/300BF-SS	300mm bolt fixing	SSS
AR303/30/300BF-PSS	300mm bolt fixing	PSS
AR303/30/350BF-SS	350mm bolt fixing	SSS
AR303/30/350BF-PSS	350mm bolt fixing	PSS

- Other lengths are available to special order

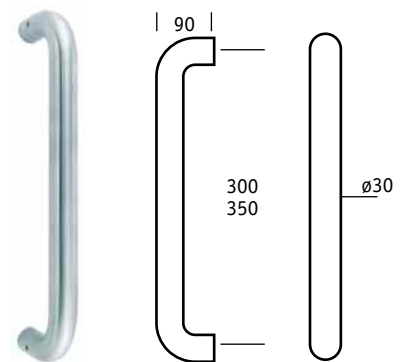
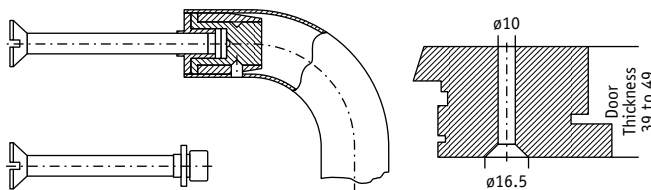

AR304/30/300BB-SS	300mm back to back fixing	SSS
AR304/30/300BB-PSS	300mm back to back fixing	PSS
AR304/30/350BB-SS	350mm back to back fixing	SSS
AR304/30/350BB-PSS	350mm back to back fixing	PSS

- Other lengths are available to special order

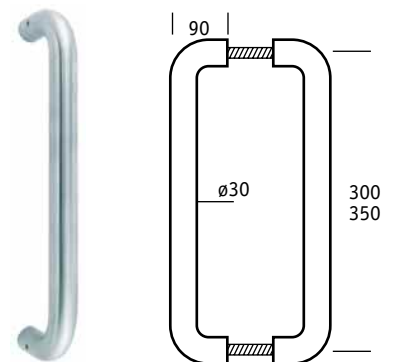
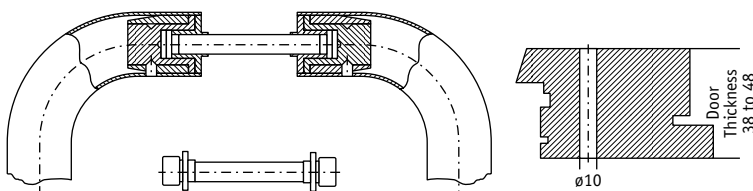

Pull Handles

Cranked Pull Handles : $\varnothing 25\text{mm}$

AR340/25/300BF-SS	300mm bolt fixing	SSS
AR340/25/300BF-PSS	300mm bolt fixing	PSS
AR340/25/350BF-SS	350mm bolt fixing	SSS
AR340/25/350BF-PSS	350mm bolt fixing	PSS

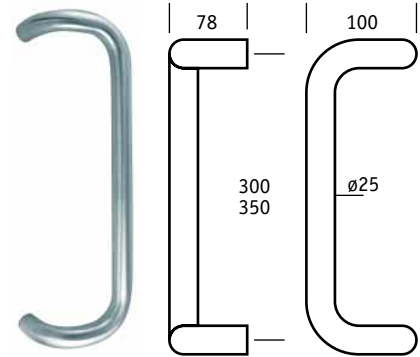
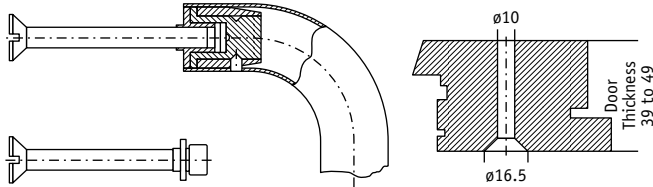

AR341/25/300BB-SS	300mm back to back fixing	SSS
AR341/25/300BB-PSS	300mm back to back fixing	PSS
AR341/25/350BB-SS	350mm back to back fixing	SSS
AR341/25/350BB-PSS	350mm back to back fixing	PSS

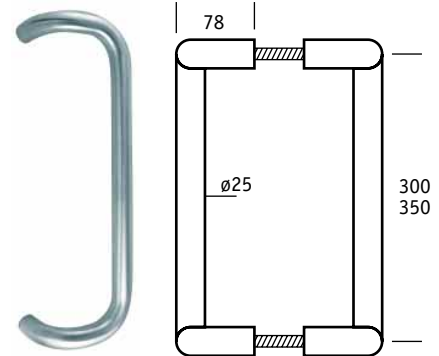
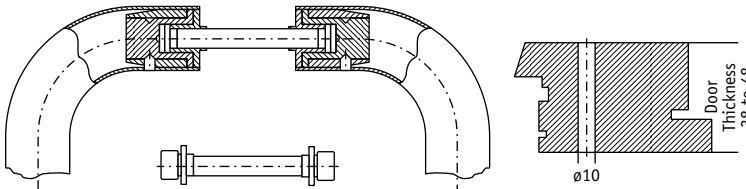

Cranked Pull Handles : $\varnothing 30\text{mm}$

AR340/30/300BF-SS	300mm bolt fixing	SSS
AR340/30/300BF-PSS	300mm bolt fixing	PSS
AR340/30/350BF-SS	350mm bolt fixing	SSS
AR340/30/350BF-PSS	350mm bolt fixing	PSS

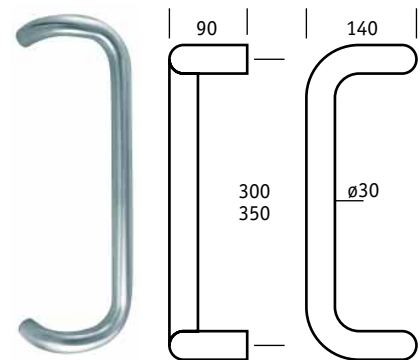
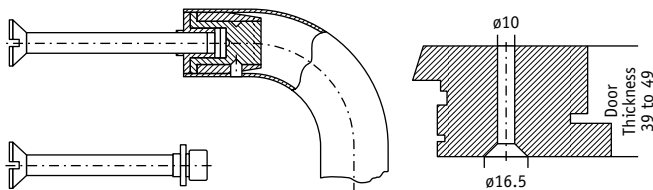

AR341/30/300BB-SS	300mm back to back fixing	SSS
AR341/30/300BB-PSS	300mm back to back fixing	PSS
AR341/30/350BB-SS	350mm back to back fixing	SSS
AR341/30/350BB-PSS	350mm back to back fixing	PSS

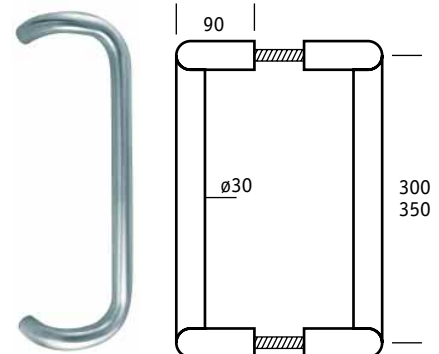
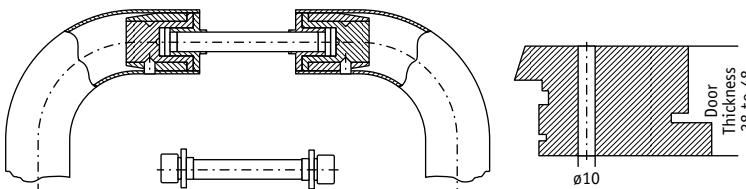

Semi-Circular Pull Handles : $\varnothing 25\text{mm}$

AR342/25/200BF-SS	200mm bolt fixing	SSS
AR342/25/200BF-PSS	200mm bolt fixing	PSS

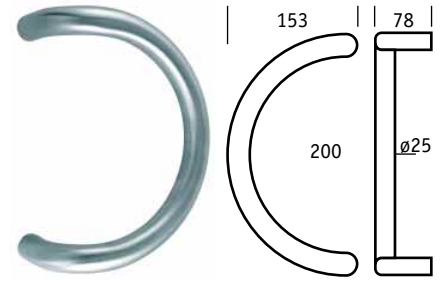
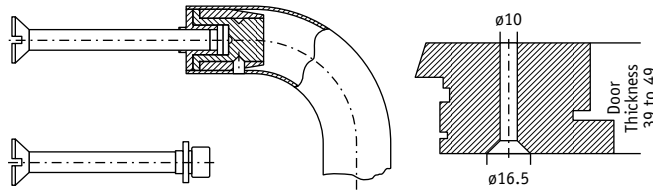

AR343/25/200BB-SS	200mm back to back fixing	SSS
AR343/25/200BB-PSS	200mm back to back fixing	PSS

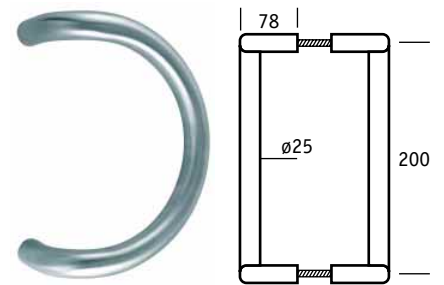
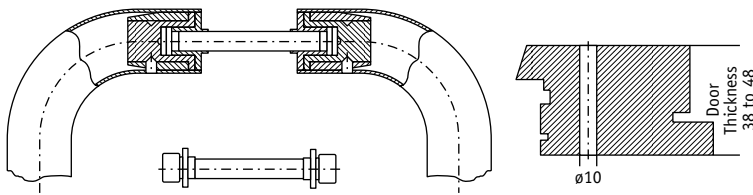

Semi-Circular Pull Handles : $\varnothing 30\text{mm}$

AR342/30/350BF-SS	350mm bolt fixing	SSS
AR342/30/350BF-PSS	350mm bolt fixing	PSS

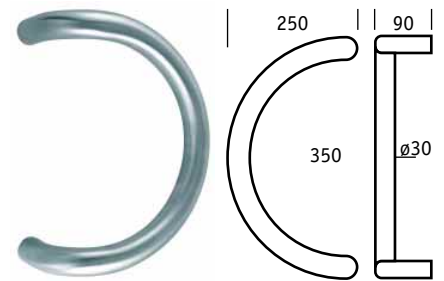
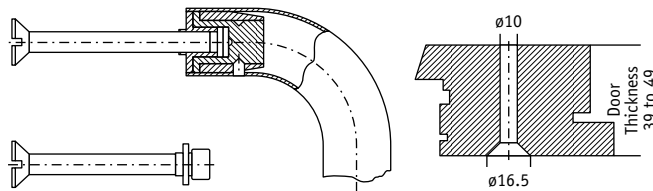

AR343/30/350BB-SS	350mm back to back fixing	SSS
AR343/30/350BB-PSS	350mm back to back fixing	PSS

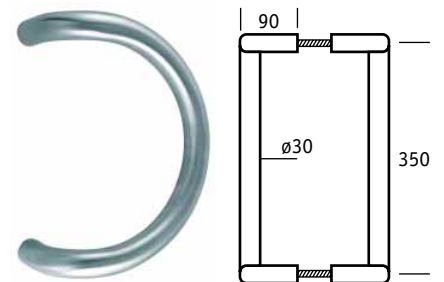
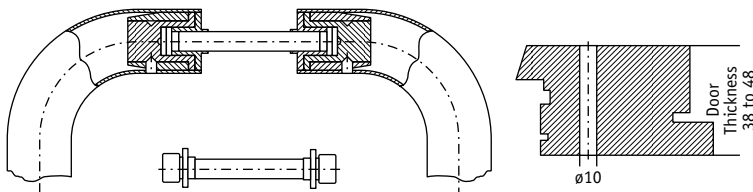

Pull Handles

Semi-Circular Pull Handles : $\varnothing 30\text{mm}$ (on $\varnothing 25\text{mm}$ Pegs)

AR344/30/200BF-SS	200mm bolt fixing	SSS
AR344/30/200BF-PSS	200mm bolt fixing	PSS
AR344/30/300BF-SS	300mm bolt fixing	SSS
AR344/30/300BF-PSS	300mm bolt fixing	PSS
AR344/30/350BF-SS	350mm bolt fixing	SSS
AR344/30/350BF-PSS	350mm bolt fixing	PSS

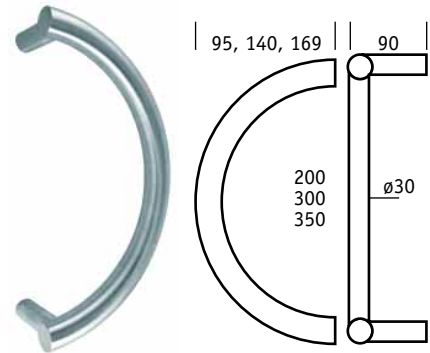
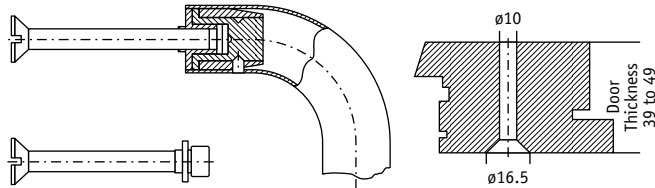

AR345/30/200BB-SS	200mm back to back fixing	SSS
AR345/30/200BB-PSS	200mm back to back fixing	PSS
AR345/30/300BB-SS	300mm back to back fixing	SSS
AR345/30/300BB-PSS	300mm back to back fixing	PSS
AR345/30/350BB-SS	350mm back to back fixing	SSS
AR345/30/350BB-PSS	350mm back to back fixing	PSS

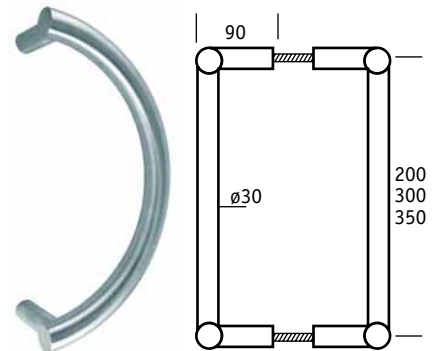
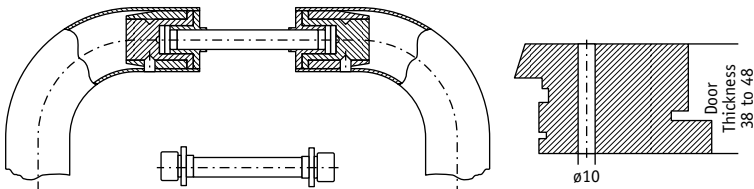

Shaped Pull Handles : $\varnothing 30$ mm (Handed)

- Handing should be specified when ordering (right hand illustrated)

AR380/30/350BF-LH-SS	350mm bolt fixing	SSS
AR380/30/350BF-RH-SS	350mm bolt fixing	SSS
AR380/30/350BF-LH-PSS	350mm bolt fixing	PSS
AR380/30/350BF-RH-PSS	350mm bolt fixing	PSS

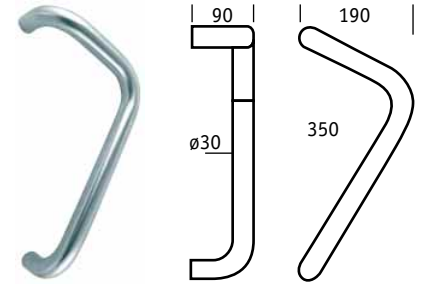
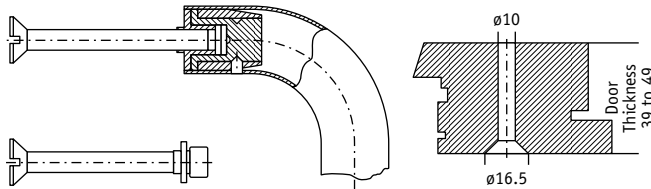

AR381/30/350BB-SS	350mm back to back fixing	SSS
AR381/30/350BB-PSS	350mm back to back fixing	PSS

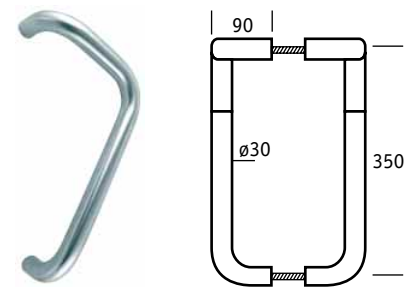
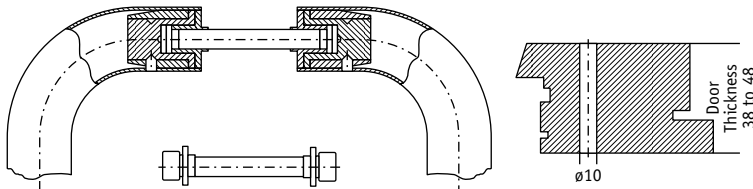

Straight Pull Handles : $\varnothing 30$ mm (on $\varnothing 25$ mm Pegs)

- Special order only - handles are manufactured to required size upon request

AR346/30BF-SS	Bolt fixing	SSS
AR346/30BF-PS	Bolt fixing	PSS

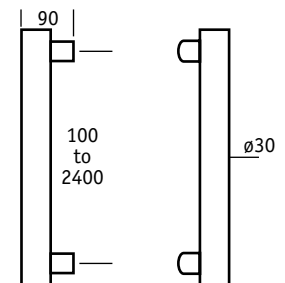
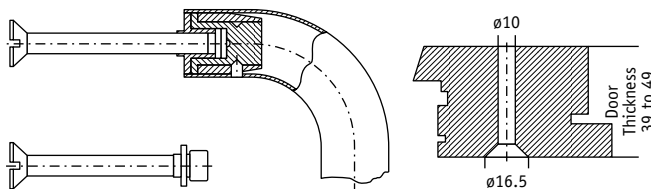

AR347/30BB-SS	Back to back fixing	SSS
AR347/30BB-PS	Back to back fixing	PSS

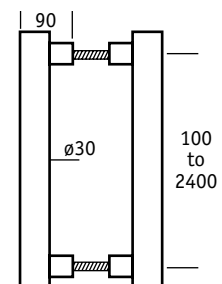
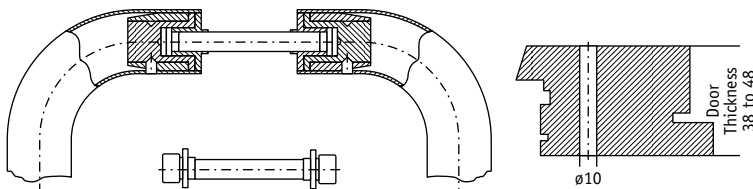

Pull Handles

V Shaped Pull Handles : $\varnothing 25\text{mm}$

AR370/25/300BF-SS	300mm bolt fixing	SSS
AR370/25/300BF-PSS	300mm bolt fixing	PSS
AR370/25/350BF-SS	350mm bolt fixing	SSS
AR370/25/350BF-PSS	350mm bolt fixing	PSS

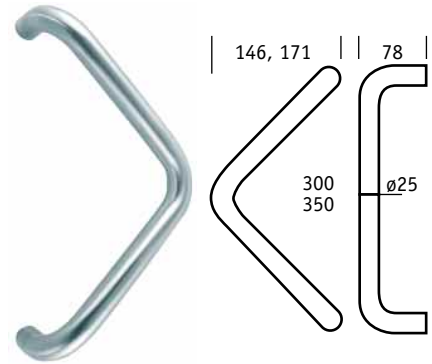
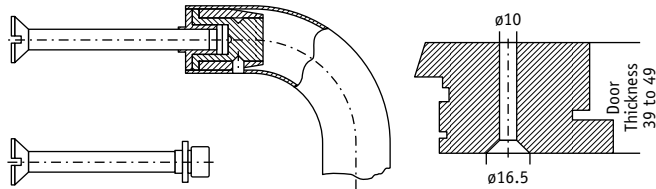

AR371/25/300BB-SS	300mm back to back fixing	SSS
AR371/25/300BB-PSS	300mm back to back fixing	PSS
AR371/25/350BB-SS	350mm back to back fixing	SSS
AR371/25/350BB-PSS	350mm back to back fixing	PSS

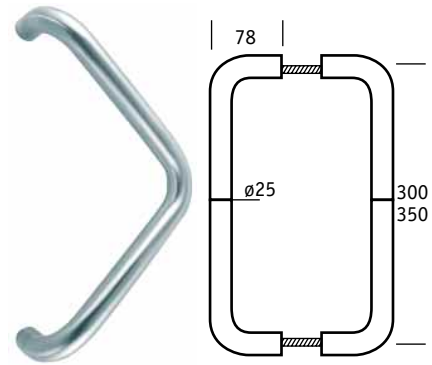
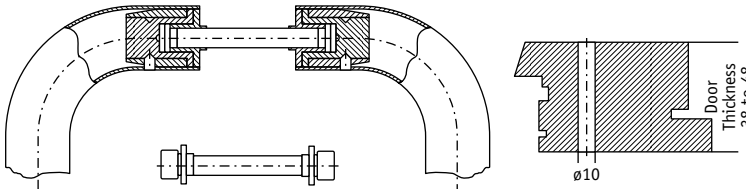

V Shaped Pull Handles : $\varnothing 30\text{mm}$

AR370/30/300BF-SS	300mm bolt fixing	SSS
AR370/30/300BF-PSS	300mm bolt fixing	PSS
AR370/30/350BF-SS	350mm bolt fixing	SSS
AR370/30/350BF-PSS	350mm bolt fixing	PSS

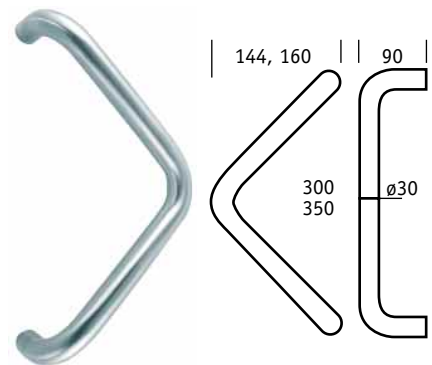
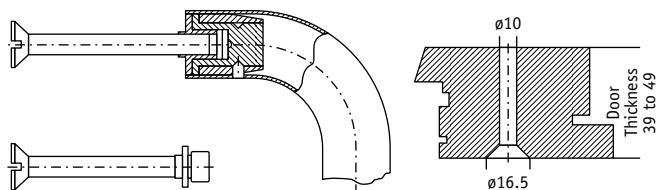

AR371/30/300BB-SS	300mm back to back fixing	SSS
AR371/30/300BB-PSS	300mm back to back fixing	PSS
AR371/30/350BB-SS	350mm back to back fixing	SSS
AR371/30/350BB-PSS	350mm back to back fixing	PSS

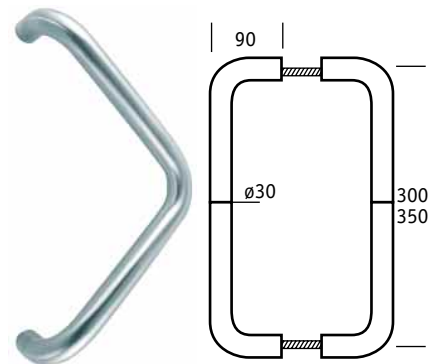
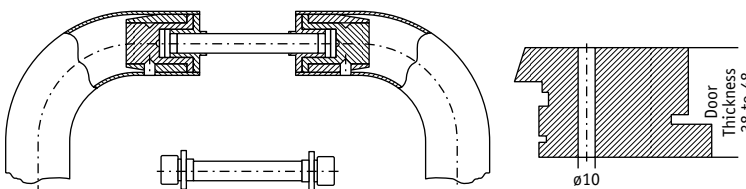

Accessories

AR306S-SS
AR306S-PSS

Cylinder pull for standard rim cylinder

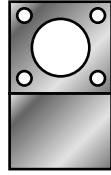

AR306YP-SS
AR306YP-PSS

Cylinder pull for euro profile cylinder

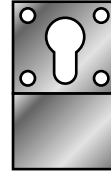

AR306U-SS
AR306U-PSS

Cylinder pull for Union oval profile cylinder

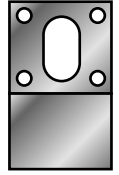

AR307M-SS
AR307M-PSS

100mm x 100mm square male wc sign



AR307F-SS
AR307F-PSS

100mm x 100mm square female wc sign



AR307D-SS
AR307D-PSS

100mm x 100mm square disabled wc sign



AR308M-SS
AR308M-PSS

ø100mm circular male wc sign

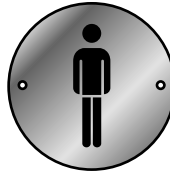

AR308F-SS
AR308F-PSS

ø100mm circular female wc sign

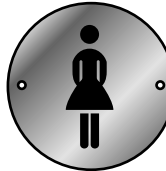

AR308D-SS
AR308D-PSS

ø100mm circular disabled wc sign



AR903M-SSS
AR903M-PSS

ø76mm circular male wc sign



AR903F-SSS
AR903F-PSS

ø76mm circular female wc sign



AR903D-SSS
AR903D-PSS

ø76mm circular disabled wc sign



AR900-SSS
AR900-PSS

ø76mm circular keep locked shut sign



AR901-SSS
AR901-PSS

ø76mm circular fire door keep locked sign



AR902-SSS
AR902-PSS

ø76mm circular fire door keep shut sign



AR904-SSS
AR904-PSS

80mm x 80mm square keep locked shut sign



AR905-SSS
AR905-PSS

80mm x 80mm square fire door keep shut sign



AR906-SSS
AR906-PSS

80mm x 80mm square fire door keep locked sign



AR907-SSS
AR907-PSS

80mm x 80mm square fire door keep locked shut sign



AR308PULL-SS
AR308PULL-PSS

ø76mm circular pull sign

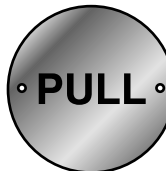

AR308PUSH-SS
AR308PUSH-PSS

ø76mm circular push sign

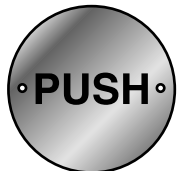

AR319-SS
AR319-PSS

Wardrobe hook

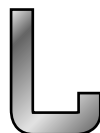

AR317-SS
AR317-PSS

Hat & coat hook

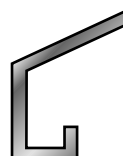

AR318-SS
AR318-PSS

Buffered hat & coat hook

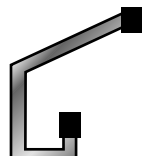

Accessories

Accessories continued...

AR315-SS

AR315-PSS

ø53mm Bell push

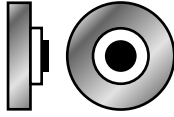

AR324A-SS

AR324A-PSS

300mm x 75mm
Finger plate
drilled and countersunk



AR324B-SS

AR324B-PSS

300mm x 75mm
Radiused finger plate
drilled and countersunk



AR324C-SS

AR324C-PSS

330mm x 75mm
Finger plate
drilled and countersunk



AR325

Kicking plates
Cut to order



AR326A-SS

AR326A-PSS

250mm x 20mm
Flush bolt

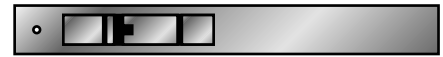

AR326B-SS

AR326B-PSS

200mm x 20mm
Flush bolt



AR334A-SS

AR334A-PSS

Door stop 76mm

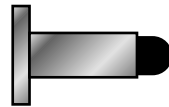

AR334B-SS

AR334B-PSS

Door stop 76mm



AR334C-SS

AR334C-PSS

30mm dia. x 20mm
Door stop

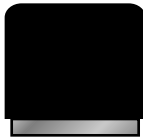

AR334D

AR334D-PSS

57mm x 55mm
Door stop

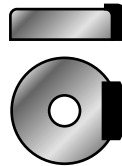

Spindles and Accessories

06855-0105-0000

8mm x 105mm full profile spindle to suit
doors up to 44mm thick

06856-2589-0000

8mm x 125mm full profile spindle to suit
doors up to 54mm thick



06850-2289-0000

8mm x 100mm split profile spindle to suit
doors up to 44mm thick

06850-6289-0000

8mm x 120mm split profile spindle to suit
doors up to 54mm thick



06825-0889-0000

8mm x 60mm half spindle to suit doors up
to 44mm thick

06885-1689-0000

8mm x 70mm half spindle to suit doors up
to 54mm thick



AR228

8mm x 100mm spindle for split follower lock



07050-1789-0000

5mm x 75mm solid spindle for
bathroom/privacy furniture



06860-1089-0000

Grub screw to suit full profile spindle



06862-5188-0000

Grub screw to suit split profile spindle



09610-0900-0000

Allen key to suit grub screws



07897-1200-0000

Fixings for glass doors (8-13mm) suitable
for pull handles ø25mm & ø30mm



Tilt & Turn Handles

Tilt & Turn Handles

Tilt & Turn Window Handles

A collection of architectural window handles designed and manufactured to complement the HOPPE series of lever handles, offering a variety of designs that can be suited throughout the project.

- Polished or satin stainless steel finish

San Francisco Series

ARE0300F/U9ZNA	Tilt & turn window handle non-locking Lugs 10mm, spindle 7mm - 32mm projecting	SSS
ARE0300F/U9ZNA	Tilt & turn window handle non-locking Lugs 10mm, spindle 7mm - 32mm projecting	PSS

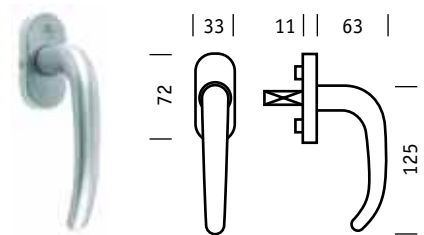

Paris Series

ARE038F/U9ZNA	Tilt & turn window handle non-locking Lugs 10mm, spindle 7mm - 32mm projecting	SSS
ARE038F/U9ZNA	Tilt & turn window handle non-locking Lugs 10mm, spindle 7mm - 32mm projecting	PSS

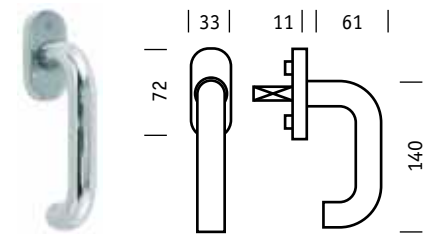

Paris Series (Locking)

ARE038FSE/U9ZNA	Tilt & turn window handle locking Lugs 10mm, spindle 7mm - 32mm projecting	SSS
ARE038FSE/U9ZNA	Tilt & turn window handle locking Lugs 10mm, spindle 7mm - 32mm projecting	PSS

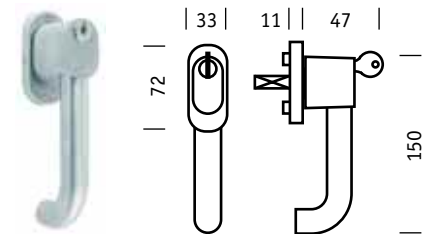

Amsterdam Series

ARE0400F/U9ZNA	Tilt & turn window handle non-locking Lugs 10mm, spindle 7mm - 32mm projecting	SSS
ARE0400F/U9ZNA	Tilt & turn window handle non-locking Lugs 10mm, spindle 7mm - 32mm projecting	PSS

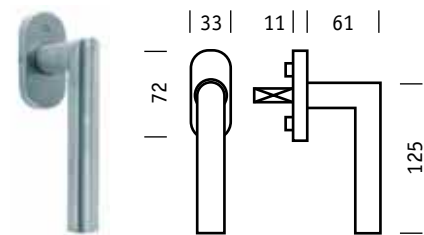

Bonn Series

ARE050F/U9ZNA	Tilt & turn window handle non-locking Lugs 10mm, spindle 7mm - 32mm projecting	SSS
ARE050F/U9ZNA	Tilt & turn window handle non-locking Lugs 10mm, spindle 7mm - 32mm projecting	PSS

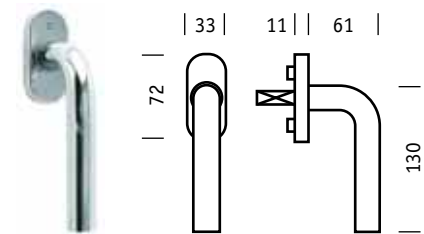

Bonn Series (Locking)

ARE050FSE/U9ZNA	Tilt & turn window handle locking Lugs 10mm, spindle 7mm - 32mm projecting	SSS
ARE050FSE/U9ZNA	Tilt & turn window handle locking Lugs 10mm, spindle 7mm - 32mm projecting	PSS

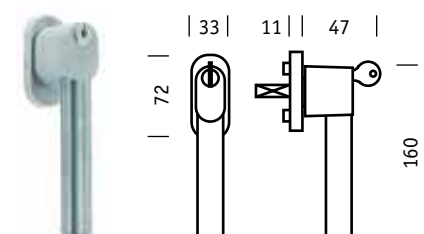

Architectural **Nylon**

ARCHITECTURAL
NYLON

Architectural Nylon

HOPPE nylon levers and pull handles are manufactured to exacting standards from polyamide nylon giving good tensile properties, impact strength and wear resistance. Nylon gives good antistatic behaviour and resistance to corrosion and chemicals. Soiling can be removed with water and/or proprietary detergents.

HOPPE nylon levers are available in either solid nylon or steel cored. The steel cored being suitable for fire doors. All handles are available in 11 RAL colours.

HOPPE nylon levers are supplied complete with full profile spindle.

Certain levers have been tested to severe duty category to PSA MOB H3 PS July 1989.

The tests have been carried out by a NAMAS accredited testing laboratory (WC 0621). They are tested to PSA and meet the requirements of BS 4951:1973

The AR600/20 levers have been included in a successful fire test in accordance with BS476 part 22 1987 to provide 2 hour fire resistance.

Pull handles are available in concealed screw fix, bolt fix or back to back fixing.

Consideration should be given to the use of the handle and bolt fixing or back to back fixing, should be specified in high use situations.



Paris Series

Paris Series

Solid Nylon Levers on Round Rose (unsprung) : $\varnothing 21\text{mm}$

- Supplied with 105mm full profile spindle

AR600/10	21mm unsprung lever on rose, 35mm to 50mm door thickness Comprising: AR600L Levers & AR600R rose
AR600/10/20	Spring cassette for above

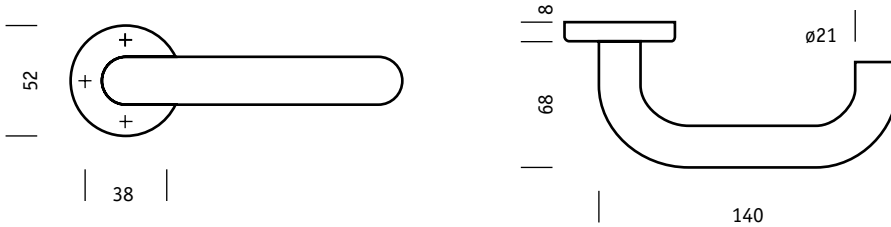

Steel Cored Levers on Round Rose (unsprung) : $\varnothing 21\text{mm}$

- Supplied with 105mm full profile spindle

AR600/20	21mm unsprung lever on rose, 35mm to 50mm door thickness Comprising: AR600SCL steel cored levers & AR600R rose
AR600/10/20	Spring cassette for above

Concealed Fix Escutcheons

AR600/26	Lever key escutcheon 52mm diameter, 38mm fixing centres
AR600/27	Euro profile escutcheon 52mm diameter, 38mm fixing centres
AR600/28	Oval profile escutcheon 52mm diameter, 38mm fixing centres

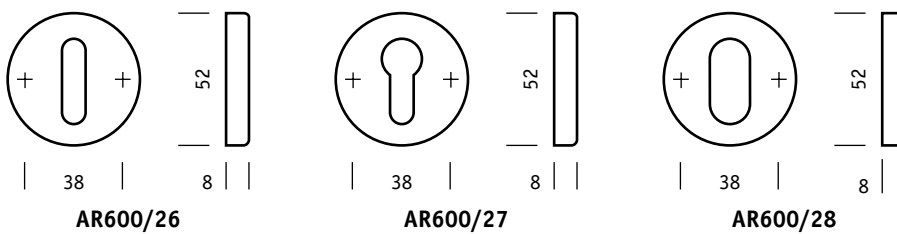

Turn & Indicator

AR600/29	Bathroom turn & indicator, 5mm spindle 52mm diameter, 38mm fixing centres
-----------------	--

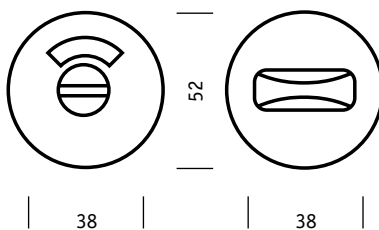

Nylon Colours



Due to the limitations of the printing process we suggest that your final choice of finish is checked against the actual product.

Solid Nylon Levers on Radius Plate (Unsprung): ø21mm

- AR600/13 also available with 72mm centres
- Supplied with 105mm full profile spindle

AR600/11	Long plate latch furniture, 35mm to 50mm door thickness Comprising: AR600L levers & AR600PLA radius latch plates
AR600/12	Lock furniture, 35mm to 50mm door thickness Comprising: AR600L levers & AR600PLO radius lock plates
AR600/13	Euro profile lock furniture, 35mm to 50mm door thickness Comprising: AR600L levers & AR600PP radius euro profile plates
AR600/14	Oval profile lock furniture, 35mm to 50mm door thickness Comprising: AR600L levers & AR600PO radius oval plates
AR600/15	Bathroom furniture, 35mm to 50mm door thickness Comprising: AR600L levers & AR600PB radius bathroom plates

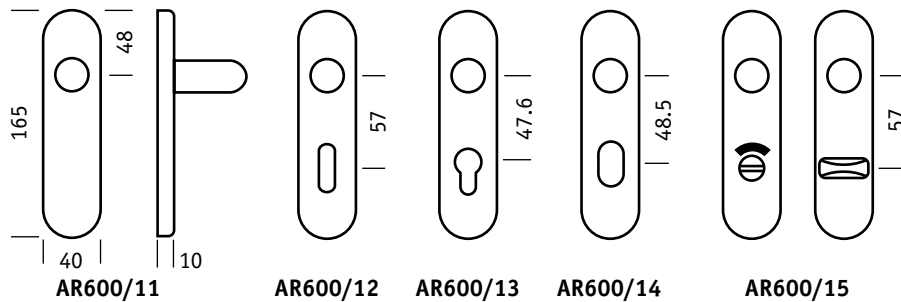

Steel Cored Levers on Radius Plate (Unsprung): ø21mm

- AR600/23 also available with 72mm centres
- Supplied with 105mm full profile spindle

AR600/21	Long plate latch furniture, 35mm to 50mm door thickness Comprising: AR600SCL levers & AR600PLA radius latch plates
AR600/22	Lock furniture, 35mm to 50mm door thickness Comprising: AR600SCL levers & AR600PLO radius lock plates
AR600/23	Euro profile lock furniture, 35mm to 50mm door thickness Comprising: AR600SCL levers & AR600PP radius euro profile plates
AR600/24	Oval profile lock furniture, 35mm to 50mm door thickness Comprising: AR600SCL levers & AR600PO radius oval plates
AR600/25	Bathroom furniture, 35mm to 50mm door thickness Comprising: AR600SCL levers & AR600PB radius bathroom plates

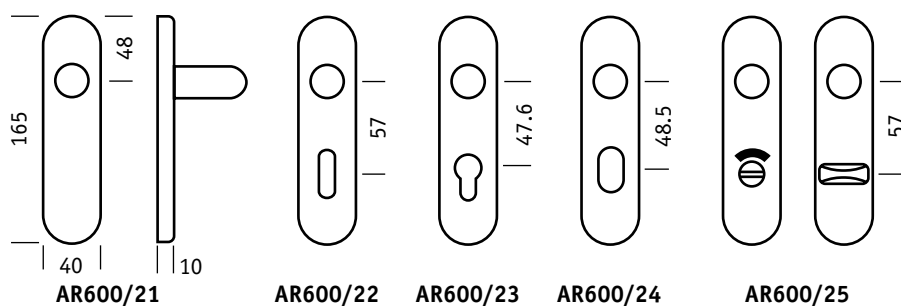

Nylon Colours

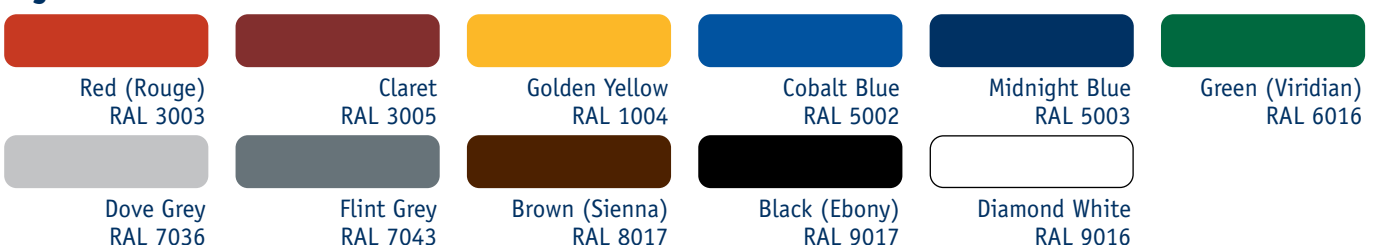

Due to the limitations of the printing process we suggest that your final choice of finish is checked against the actual product.

Paris Series

Solid Nylon Levers on Oblong Plate (Unsprung): ø21mm

- AR600/33 also available with 72mm centres
- Supplied with 105mm full profile spindle

AR600/31	Long plate latch furniture, 35mm to 50mm door thickness Comprising: AR600L levers & AR6/11 oblong latch plates
AR600/32	Lock furniture, 35mm to 50mm door thickness Comprising: AR600L levers & AR6/12 oblong lock plates
AR600/33	Euro profile lock furniture, 35mm to 50mm door thickness Comprising: AR600L levers & AR6/13 oblong euro profile plates
AR600/34	Oval profile lock furniture, 35mm to 50mm door thickness Comprising: AR600L levers & AR6/14 oblong oval plates
AR600/35	Bathroom furniture, 35mm to 50mm door thickness Comprising: AR600L levers & AR6/15 oblong bathroom plates

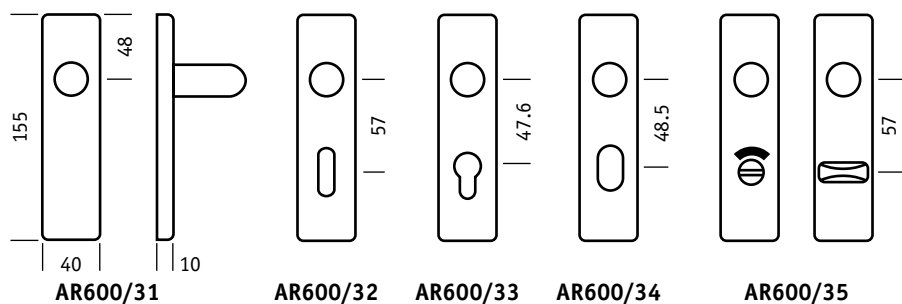

Steel Cored Levers on Oblong Plate (Unsprung): ø21mm

- AR600/43 also available with 72mm centres
- Supplied with 105mm full profile spindle

AR600/41	Long plate latch furniture, 35mm to 50mm door thickness Comprising: AR600SCL levers & AR6/11 oblong latch plates
AR600/42	Lock furniture, 35mm to 50mm door thickness Comprising: AR600SCL levers & AR6/12 oblong lock plates
AR600/43	Euro profile lock furniture, 35mm to 50mm door thickness Comprising: AR600SCL levers & AR6/13 oblong euro profile plates
AR600/44	Oval profile lock furniture, 35mm to 50mm door thickness Comprising: AR600SCL levers & AR6/14 oblong oval plates
AR600/45	Bathroom furniture, 35mm to 50mm door thickness Comprising: AR600SCL levers & AR6/15 oblong bathroom plates

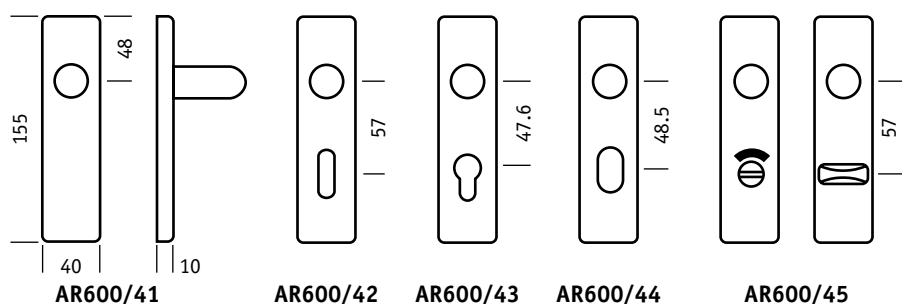

Nylon Colours

Red (Rouge) RAL 3003	Claret RAL 3005	Golden Yellow RAL 1004	Cobalt Blue RAL 5002	Midnight Blue RAL 5003	Green (Viridian) RAL 6016
Dove Grey RAL 7036	Flint Grey RAL 7043	Brown (Sienna) RAL 8017	Black (Ebony) RAL 9017	Diamond White RAL 9016	

Due to the limitations of the printing process we suggest that your final choice of finish is checked against the actual product.



Pull Handles

Pull Handles

Steel Cored Straight Pull Handles : $\varnothing 23\text{mm}$

AR602/160CF

165.5mm centres, concealed screw fixing

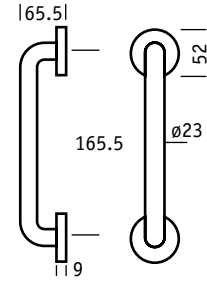
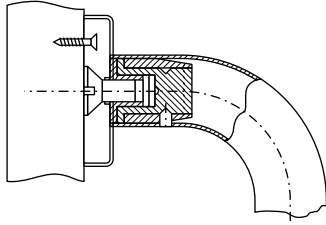

AR602/160BF

165.5mm centres, bolt fixing c/w matching bolt cover caps

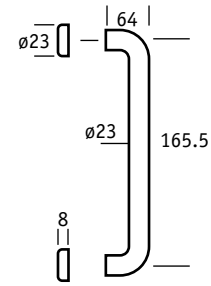
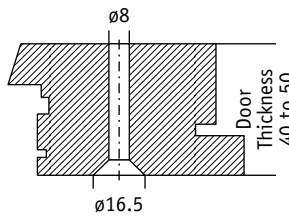
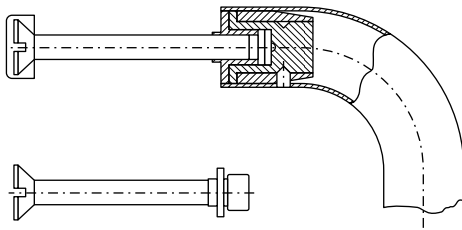

Steel Cored Straight Pull Handles : $\varnothing 34\text{mm}$

AR602/220CF

220mm centres, concealed screw fixing

AR602/300CF

300mm centres, concealed screw fixing

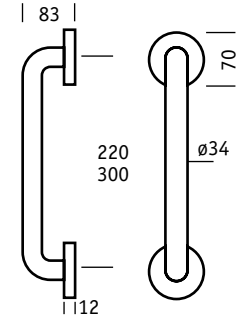
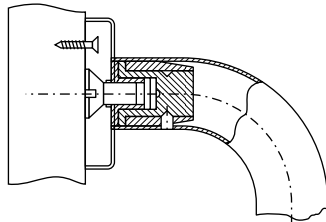

AR602/220BF

220mm centres, bolt fixing c/w matching bolt cover caps

AR602/300BF

300mm centres, bolt fixing c/w matching bolt cover caps

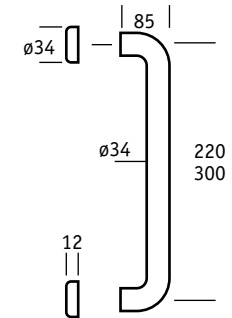
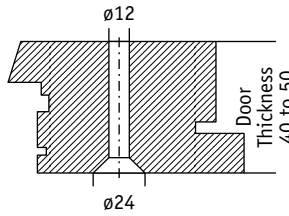
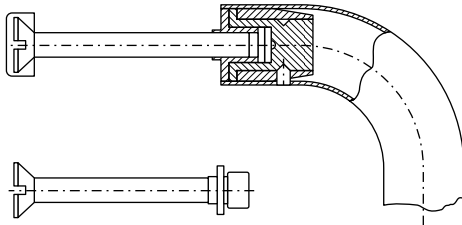

AR602/220BB

220mm centres, back to back fixing

AR602/300BB

300mm centres, back to back fixing

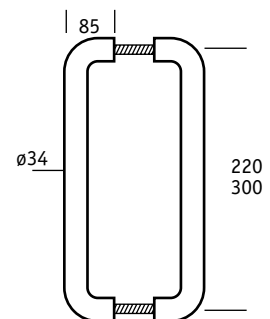
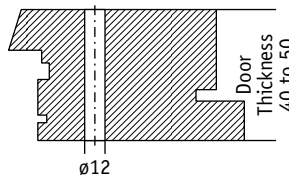
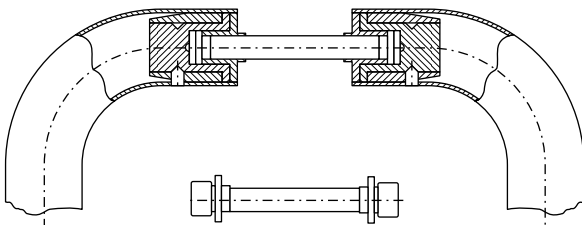

Steel Cored Cranked Pull Handles : $\varnothing 34\text{mm}$

AR603/200CF	200mm centres, concealed screw fixing
AR603/300CF	300mm centres, concealed screw fixing

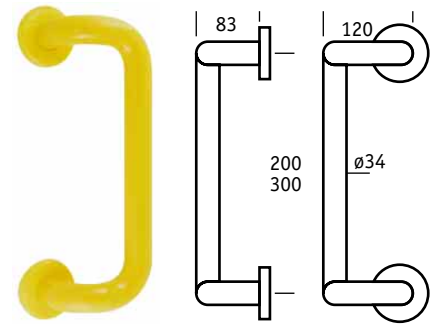
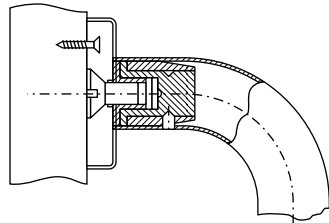

AR603/200BF	200mm centres, bolt fixing c/w matching bolt cover caps
AR603/300BF	300mm centres, bolt fixing c/w matching bolt cover caps

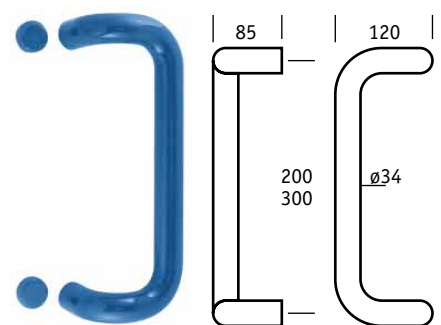
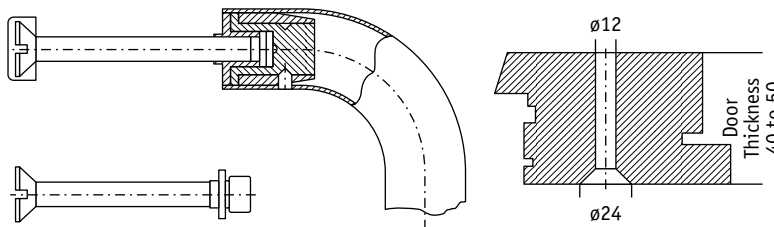

AR603/200BB	200mm centres, back to back fixing
AR603/300BB	300mm centres, back to back fixing

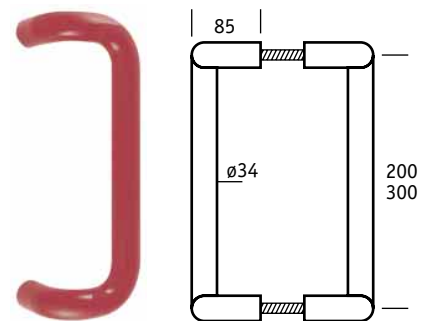
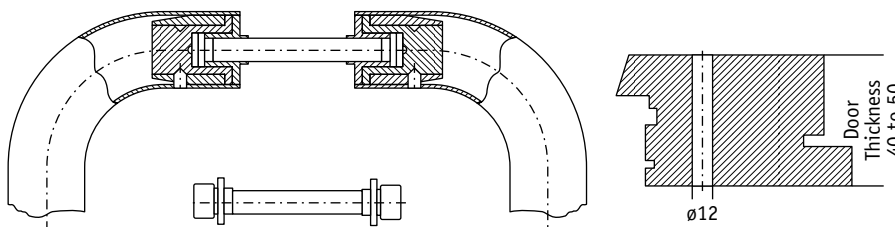

Nylon Colours

Red (Rouge) RAL 3003	Claret RAL 3005	Golden Yellow RAL 1004	Cobalt Blue RAL 5002	Midnight Blue RAL 5003	Green (Viridian) RAL 6016
Dove Grey RAL 7036	Flint Grey RAL 7043	Brown (Sienna) RAL 8017	Black (Ebony) RAL 9017	Diamond White RAL 9016	

Due to the limitations of the printing process we suggest that your final choice of finish is checked against the actual product.

Pull Handles

Steel Cored V Shaped Pull Handles : $\varnothing 34\text{mm}$

AR604/300BF

300mm centres, bolt fixing c/w matching bolt cover caps

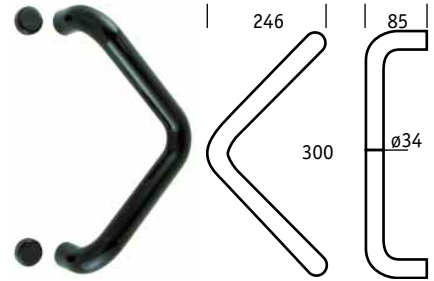
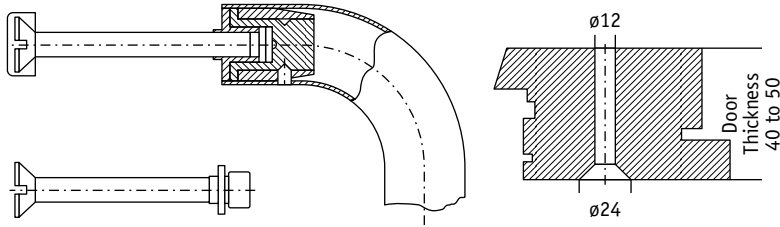

AR604/300BB

300mm centres, back to back fixing

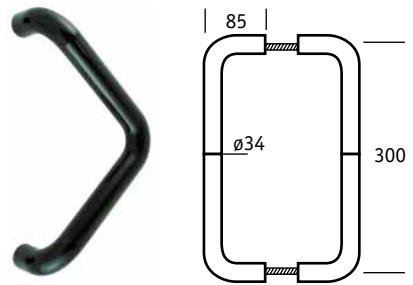
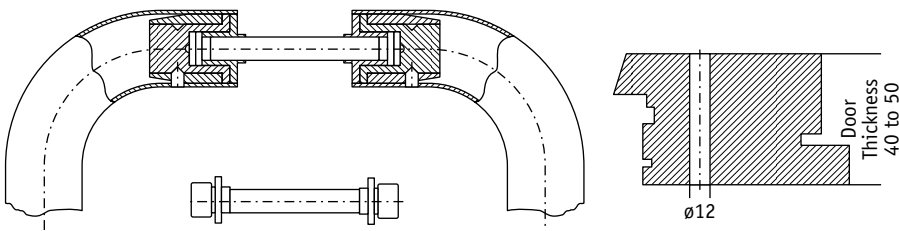

Steel Cored Semi-Circular Pull Handles : $\varnothing 34\text{mm}$

AR605/300BF

300mm centres, bolt fixing c/w matching bolt cover caps

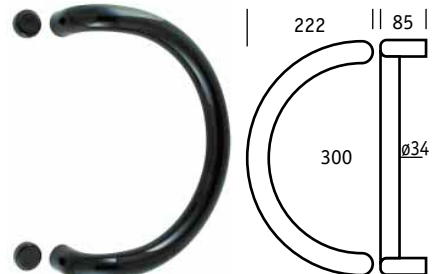
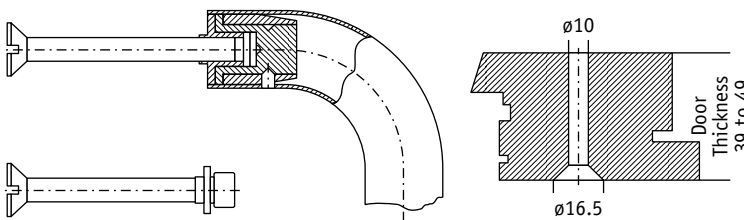

AR605/300BB

300mm centres, back to back fixing

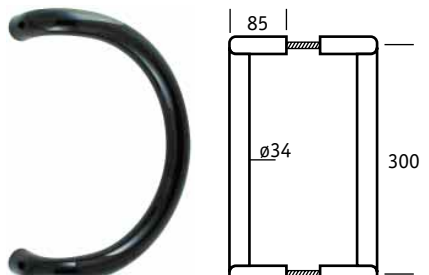
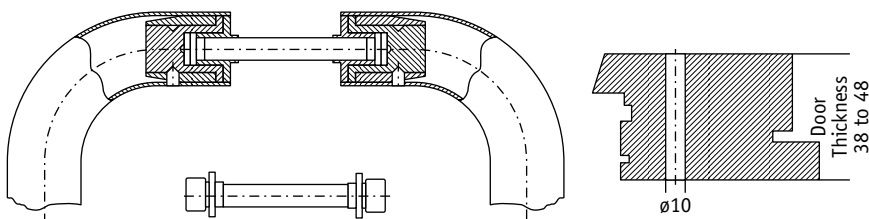



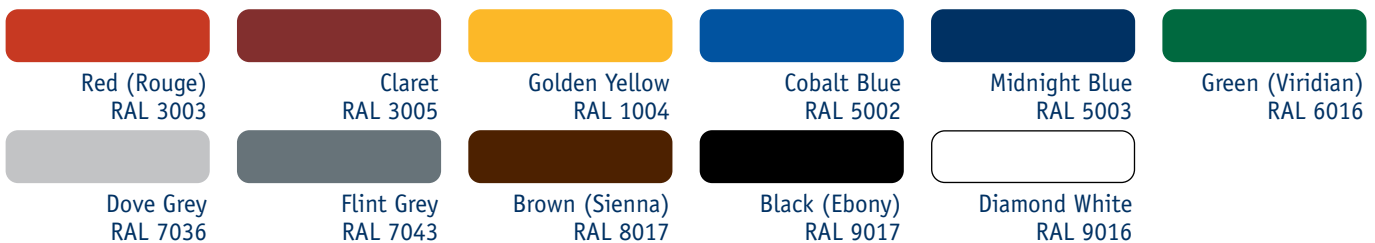

Nylon Colours

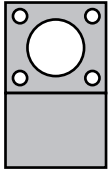
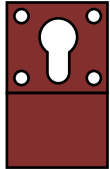
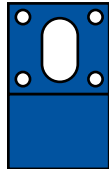

Due to the limitations of the printing process we suggest that your final choice of finish is checked against the actual product.

Accessories

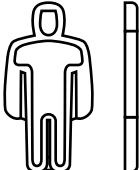
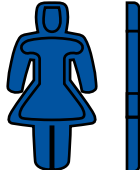
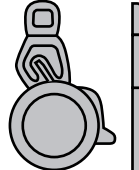
<p>AR606S Cylinder pull for standard rim cylinder</p>		<p>AR606YP Cylinder pull for euro profile cylinder</p>		<p>AR606U Cylinder pull for union oval profile cylinder</p>	
<p>AR607M 100mm x 150mm oblong male wc symbol</p>		<p>AR607F 100mm x 150mm oblong female wc symbol</p>		<p>AR607D 100mm x 150mm oblong disabled wc symbol</p>	
<p>AR607IM International male wc symbol concealed fix 80mm x 150mm</p>		<p>AR607IF International female wc symbol concealed fix 80mm x 150mm</p>		<p>AR607ID International disabled wc symbol concealed fix 80mm x 150mm</p>	
<p>AR608A 380mm x 90mm (aperture 250mm x 50mm) letter plate & flap</p>	<p>AR609C 380mm x 90mm (aperture 250mm x 50mm) letter flap only</p>	<p>AR610A 150mm surface door bolt</p>			
<p>AR610B 200mm surface door bolt</p>	<p>AR610C 19mm x 200mm flush bolt</p>	<p>AR612 ø32mm floor/wall mounted door stop 20mm projection</p>			
<p>AR613 ø52mm wall mounted door stop 40mm projection</p>	<p>AR614 Wall mounted door stop 75mm</p>	<p>AR615 ø52mm bell push</p>			
<p>AR617A hat & coat hook face fix</p>	<p>AR617B hat & coat hook concealed fix</p>	<p>AR618 Coat hook face fix</p>			
<p>AR619 Coat hook concealed fix</p>	<p>AR620 Toilet roll holder</p>	<p>AR620PP Toilet roll holder locking AR620PK Key for AR620PP</p>			

Accessories

Accessories continued...

AR626

160mm x 220mm
towel ring

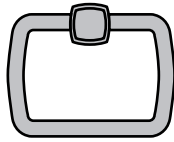

AR627

22mm x 478mm
towel rail



AR621

ø40mm cupboard knob
40mm projection



AR622A

10mm x 64mm
cabinet handle
32mm projection
screw fixing from back



AR622B

12mm x 96mm
cabinet handle
38mm projection
screw fixing from back



AR622C

20mm x 128mm
cabinet handle
55mm projection
screw fixing from back



AR624A

Finger plate
75mm x 305mm
self-adhesive



AR624B

Radius finger plate
75mm x 305mm
self-adhesive

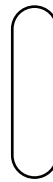

AR628A

75mm 1838 colour coated
steel butt hinges
c/w screws

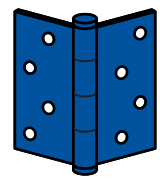

AR628B

100mm 1838 colour coated
steel butt hinges
c/w screws

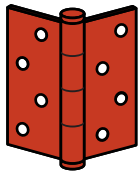

AR628C

75mm 451 colour coated
heavy steel butt hinges
c/w screws

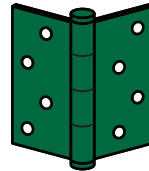

AR628D

100mm 451 colour coated
heavy steel butt hinges
c/w screws

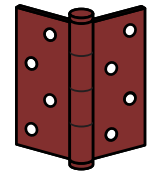

AR625

Kicking plate
Cut to order
Self adhesive



Spindles and Accessories

06856-2589-0000

8mm x 125mm full profile spindle to suit
doors up to 54mm thick



06855-0105-0000

8mm x 105mm full profile spindle to suit
doors up to 44mm thick



07810-5200-0012

Back to back fixings for glass doors
(8-13mm) suitable for pull handles
ø34mm (except AR605)

07897-1200-0000

Back to back fixings for glass doors
(8-13mm) suitable for pull handles
ø34mm (AR605 only)

09610-0900-0000

Allen key to suit grub screws



07050-1789-0000

5mm x 75mm solid spindle for
bathroom/privacy furniture



06860-1089-0000

Grub screw to suit full profile spindle



Architectural **Aluminium**

Architectural Aluminium

HOPPE aluminium handles are produced using high quality, corrosion resistant alloys. The surface finish of HOPPE aluminium products is by anodising, which gives certain protection against atmospheric corrosion, perspiration from hands, and light scratching.

Aluminium does not need special care because the oxide film protects the surface. Dirt spots can be removed with a soft cloth and water.

Aluminium levers on round rose are available either sprung or unsprung and are supplied complete with the **HOPPE** full profile spindle, and bolt fixings for a more secure fix to the door.

Pull handles are available in concealed screw fix, bolt fix or back to back fixing. Consideration should be given to the use of the handle, and bolt fix or back to back fix should be specified in high use situations.

HOPPE aluminium levers and pull handles are ideal for use in public buildings, offices, hospitals, and hotels where quality and performance is required at an attractive price.

Certain levers have been tested to severe duty category to PSA MOB H3 PS July 1989.

The tests have been carried out by a NAMAS accredited testing laboratory (WC 0621). They are tested to PSA and meet the requirements of BS 4951:1973

The AR200/10 levers have been included in a successful 1/2 hour fire test in accordance with BS476 part 22 1987 at the Warrington Fire Research and Testing Centre.



Verona Series

Verona Series

Levers on Round Rose

- AR280/10 supplied complete with bolt fixings & screws

AR280/10	Sprung lever on rose, 100mm split profile spindle Nylon understructure, 4 point fixing, 35mm to 50mm door thickness	SAA
AR280/10UN	Unsprung lever on rose, 100mm split profile spindle Nylon understructure, 2 point fixing, 35mm to 50mm door thickness	SAA

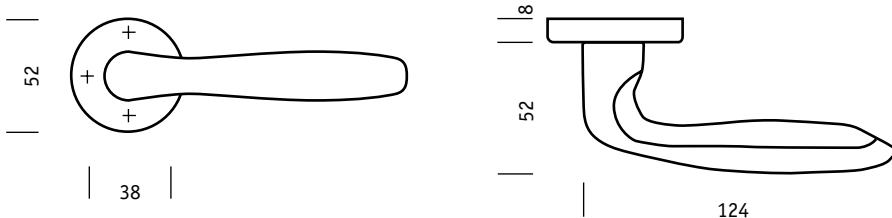

Concealed Fix Escutcheons

AR200/26	Lever key escutcheon 52mm diameter, 38mm fixing centres	SAA
AR200/27	Euro profile escutcheon 52mm diameter, 38mm fixing centres	SAA
AR200/28	Oval profile escutcheon 52mm diameter, 38mm fixing centres	SAA
AR200/30	Blind escutcheon 52mm diameter, 38mm fixing centres	SAA

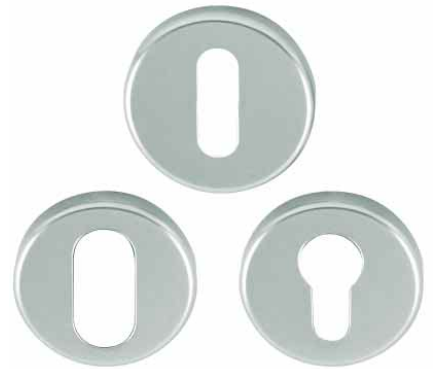
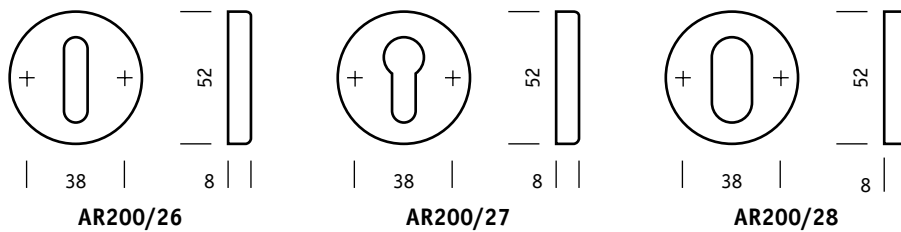

Bathroom Turn & Indicator

AR200/29	Bathroom turn & indicator 52mm diameter, 38mm fixing centres, 5mm spindle	SAA
AR200/29D	Disabled turn & indicator 52mm diameter, 38mm fixing centres, 5mm spindle	SAA

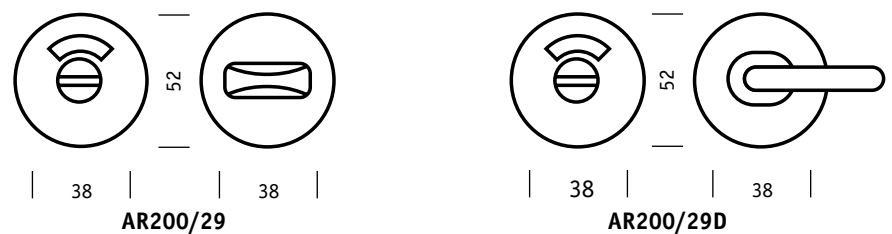

Levers on Concealed Fix Oblong Plate (sprung)

- 8mm x 105mm full profile spindle
- Suitable for 35mm to 50mm door thickness
- Supplied complete with bolt fixings

AR280/11	Long plate latch furniture	SAA
AR280/12	Lock furniture	SAA
AR280/13	Euro profile lock furniture	SAA
AR280/13G	Euro profile lock furniture for Guardian 51mm centres	SAA
AR280/14	Oval profile lock furniture	SAA
AR280/15	Bathroom furniture	SAA

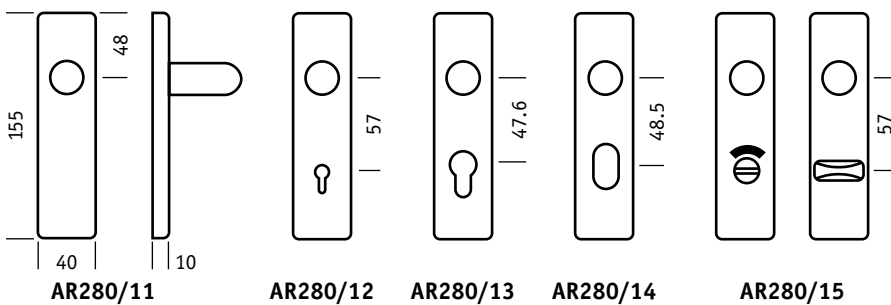

Levers on Concealed Fix Radius Plate (sprung)

- 8mm x 105mm full profile spindle
- Suitable for 35mm to 50mm door thickness
- Supplied complete with bolt fixings

AR280/31	Long plate latch furniture	SAA
AR280/32	Lock furniture	SAA
AR280/33	Euro profile lock furniture	SAA
AR280/33G	Euro profile lock furniture for Guardian 51mm centres	SAA
AR280/34	Oval profile lock furniture	SAA
AR280/35	Bathroom furniture	SAA

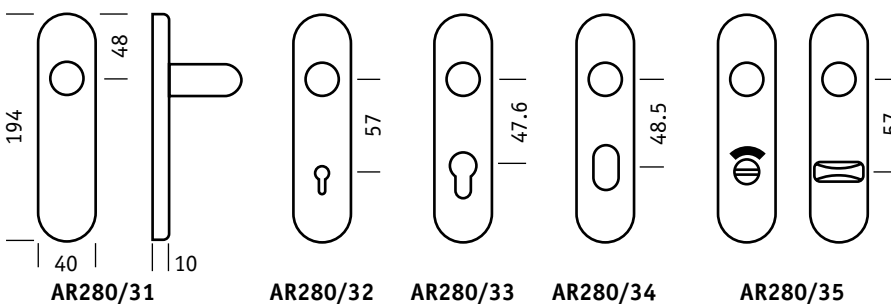

Verona Series

Levers on 160mm x 64mm Face Fix Plate (unsprung)

- 8mm x 100mm full profile spindle
- Suitable for 35mm to 50mm door thickness

AR280/21	Long plate latch furniture	SAA
AR280/22	Lock furniture	SAA
AR280/23	Euro profile lock furniture	SAA
AR280/24	Oval profile lock furniture	SAA
AR280/25	Bathroom furniture	SAA

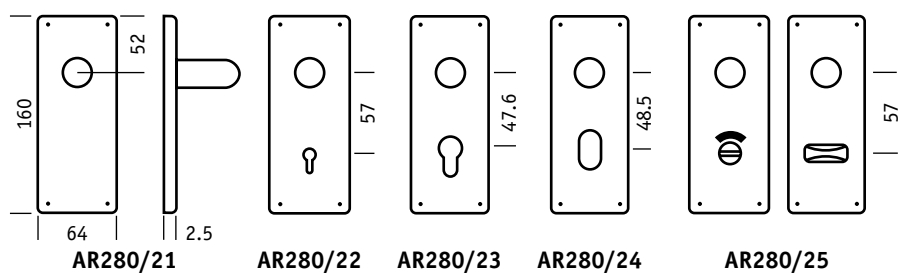

Levers on 160mm x 160mm Face Fix Plate (unsprung)

- 8mm x 100mm full profile spindle
- Suitable for 35mm to 50mm door thickness

AR280/16	Latch furniture	SAA
AR280/17	Lock furniture	SAA
AR280/18	Euro profile lock furniture	SAA
AR280/19	Oval profile lock furniture	SAA
AR280/20	Bathroom furniture (please state hand)	SAA

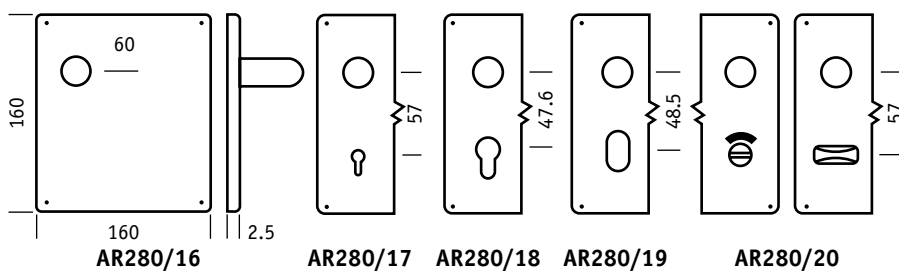



Paris Series

Paris Series

Levers on Round Rose : $\varnothing 20\text{mm}$

- AR200/10 & AR200/10GE supplied complete with bolt fixings & screws

AR200/10	20mm sprung lever on rose, 100mm split profile spindle Nylon understructure, 4 point fixing, 35mm to 50mm door thickness	SAA
AR200/10UN	20mm unsprung lever on rose, 100mm split profile spindle Nylon understructure, 2 point fixing, 35mm to 50mm door thickness	SAA
AR200/10GE	20mm sprung lever on rose, 100mm split profile spindle Nylon understructure, 4 point fixing, 35mm to 50mm door thickness	GOLD
AR200/10LHHALF	1/2 set 20mm sprung lever on rose left hand Nylon understructure, 4 point fixing with half spindle	SAA
AR200/10RHHALF	1/2 set 20mm sprung lever on rose right hand Nylon understructure, 4 point fixing with half spindle	SAA



Levers on Round Rose : $\varnothing 22\text{mm}$

- AR220/10 supplied complete with bolt fixings & screws

AR220/10	22mm sprung lever on rose, 100mm split profile spindle Nylon understructure, 4 point fixing, 35mm to 50mm door thickness	SAA
AR220/10UN	22mm unsprung lever on rose, 100mm split profile spindle Nylon understructure, 2 point fixing, 35mm to 50mm door thickness	SAA

Concealed Fix Escutcheons

- 52mm diameter, 38mm fixing centres

AR200/26	Lever key escutcheon	SAA
AR200/26GE	Lever key escutcheon	GOLD
AR200/27	Euro profile escutcheon	SAA
AR200/27GE	Euro profile escutcheon	GOLD
AR200/28	Oval profile escutcheon	SAA
AR200/28GE	Oval profile escutcheon	GOLD
AR200/30	Blind escutcheon	SAA
AR200/30GE	Blind escutcheon	GOLD

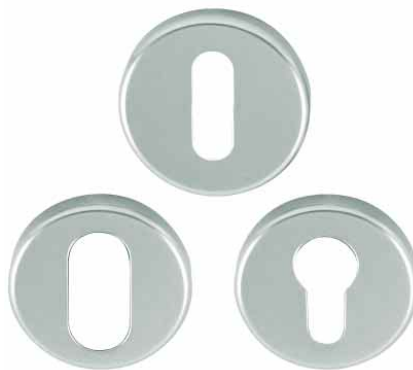
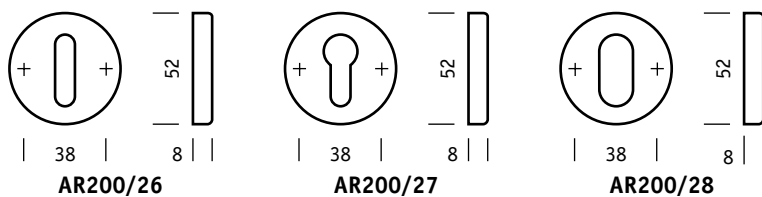

Bathroom Turn & Indicator

AR200/29	Bathroom turn & indicator 52mm diameter, 38mm fixing centres, 5mm spindle	SAA
AR200/29G	Bathroom turn & indicator 52mm diameter, 38mm fixing centres, 5mm spindle	GOLD
AR200/29D	Disabled turn & indicator 52mm diameter, 38mm fixing centres, 5mm spindle	SAA



Levers on Concealed Fix Oblong Plate (sprung) : ø20mm

- 8mm x 105mm full profile spindle
- Suitable for 35mm to 50mm door thickness
- Supplied complete with bolt fixings

AR200/11	Long plate latch furniture	SAA
AR200/11G	Long plate latch furniture	GOLD
AR200/12	Lock furniture	SAA
AR200/12G	Lock furniture	GOLD
AR200/13	Euro profile lock furniture	SAA
AR200/13GE	Euro profile lock furniture	GOLD
AR200/13G	Euro profile lock furniture for Guardian 51mm centres	SAA
AR200/14	Oval profile lock furniture	SAA
AR200/14G	Oval profile lock furniture	GOLD
AR200/15	Bathroom furniture	SAA
AR200/15G	Bathroom furniture	GOLD

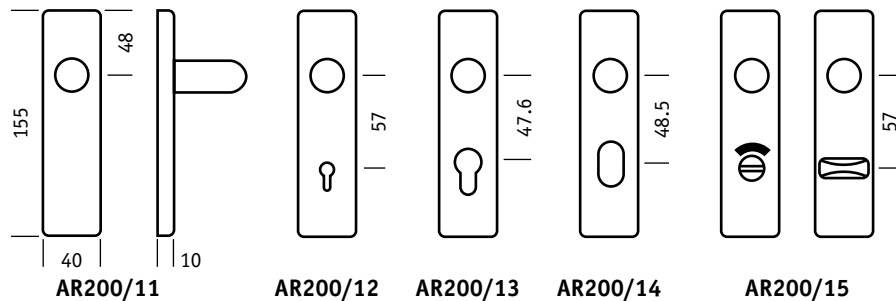

Levers on Concealed Fix Oblong Plate (sprung) : ø22mm

- 8mm x 105mm full profile spindle
- Suitable for 35mm to 50mm door thickness
- Supplied complete with bolt fixings

AR220/11	Long plate latch furniture	SAA
AR220/12	Lock furniture	SAA
AR220/13	Euro profile lock furniture	SAA
AR220/13G	Euro profile lock furniture for Guardian 51mm centres	SAA
AR220/14	Oval profile lock furniture	SAA
AR220/15	Bathroom furniture	SAA

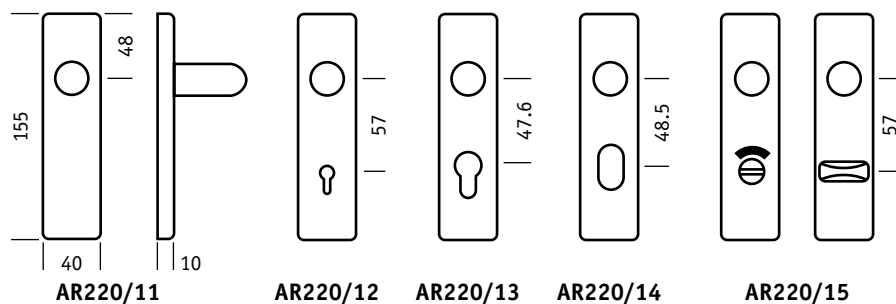

Paris Series

Levers on Concealed Fix Radius Plate (sprung) : $\varnothing 20\text{mm}$

- 8mm x 105mm full profile spindle
- Suitable for 35mm to 50mm door thickness
- Supplied complete with bolt fixings

AR200/31	Long plate latch furniture	SAA
AR200/31GE	Long plate latch furniture	GOLD
AR200/32	Lock furniture	SAA
AR200/32GE	Lock furniture	GOLD
AR200/33	Euro profile lock furniture	SAA
AR200/33GE	Euro profile lock furniture	GOLD
AR200/33G	Euro profile lock furniture for Guardian 51mm centres	SAA
AR200/34	Oval profile lock furniture	SAA
AR200/34GE	Oval profile lock furniture	GOLD
AR200/35	Bathroom furniture	SAA
AR200/35GE	Bathroom furniture	GOLD

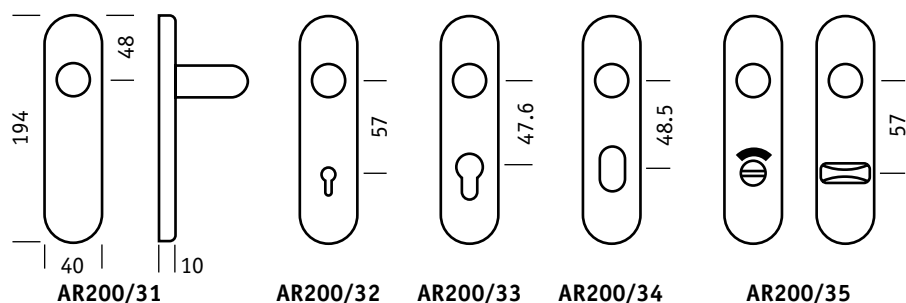

Levers on Concealed Fix Radius Plate (sprung) : $\varnothing 22\text{mm}$

- 8mm x 105mm full profile spindle
- Suitable for 35mm to 50mm door thickness
- Supplied complete with bolt fixings

AR220/31	Long plate latch furniture	SAA
AR220/32	Lock furniture	SAA
AR220/33	Euro profile lock furniture	SAA
AR220/33G	Euro profile lock furniture for Guardian 51mm centres	SAA
AR220/34	Oval profile lock furniture	SAA
AR220/35	Bathroom furniture	SAA

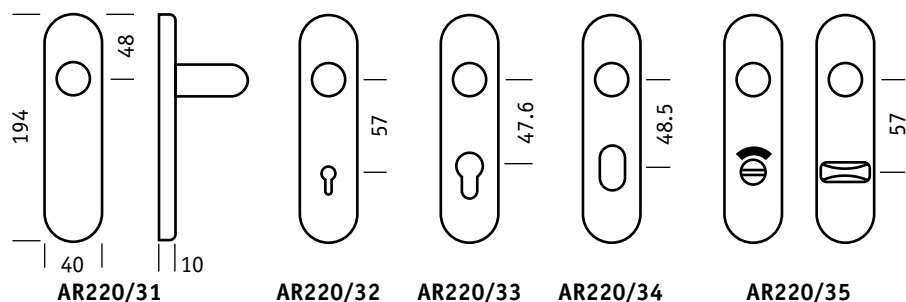

Levers on 160mm x 64mm Face Fix Plate (unsprung) : ø20mm

- 8mm x 100mm full profile spindle
- Suitable for 35mm to 50mm door thickness

AR200/21	Long plate latch furniture	SAA
AR200/22	Lock furniture	SAA
AR200/23	Euro profile lock furniture	SAA
AR200/24	Oval profile lock furniture	SAA
AR200/25	Bathroom furniture	SAA

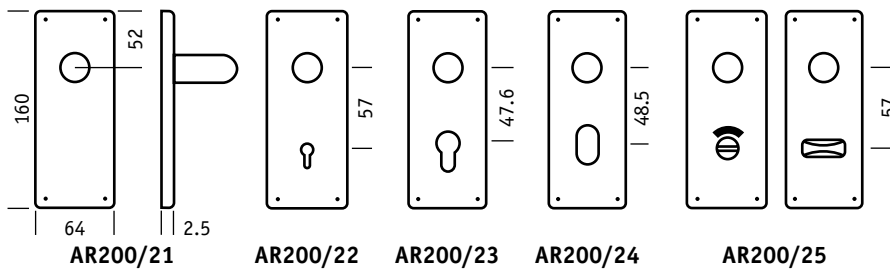

Levers on 160mm x 64mm Face Fix Plate (unsprung) : ø22mm

- 8mm x 100mm full profile spindle
- Suitable for 35mm to 50mm door thickness

AR220/21	Long plate latch furniture	SAA
AR220/22	Lock furniture	SAA
AR220/23	Euro profile lock furniture	SAA
AR220/24	Oval profile lock furniture	SAA
AR220/25	Bathroom furniture	SAA

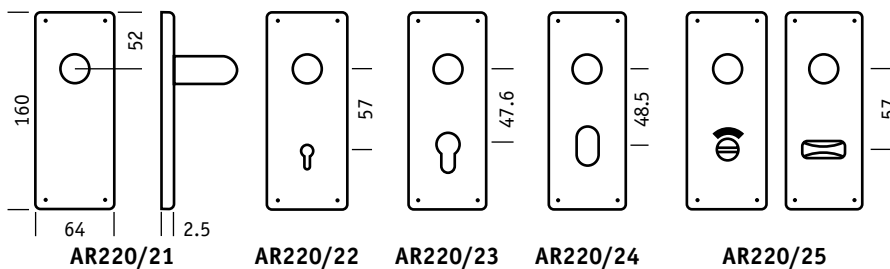

Paris Series

Levers on 160mm x 160mm Face Fix Plate (unsprung) : $\varnothing 20\text{mm}$

- 8mm x 100mm full profile spindle
- Suitable for 35mm to 50mm door thickness

AR200/16	Latch furniture	SAA
AR200/17	Lock furniture	SAA
AR200/18	Euro profile lock furniture	SAA
AR200/19	Oval profile lock furniture	SAA
AR200/20	Bathroom furniture (please state hand)	SAA

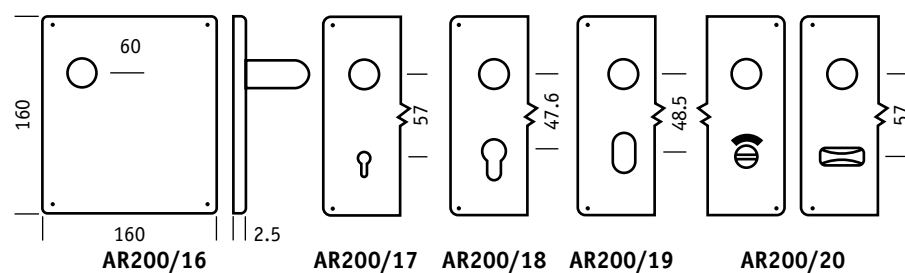

Levers on 160mm x 160mm Face Fix Plate (unsprung) : $\varnothing 22\text{mm}$

- 8mm x 100mm full profile spindle
- Suitable for 35mm to 50mm door thickness

AR220/16	Latch furniture	SAA
AR220/17	Lock furniture	SAA
AR220/18	Euro profile lock furniture	SAA
AR220/19	Oval profile lock furniture	SAA
AR220/20	Bathroom furniture (please state hand)	SAA

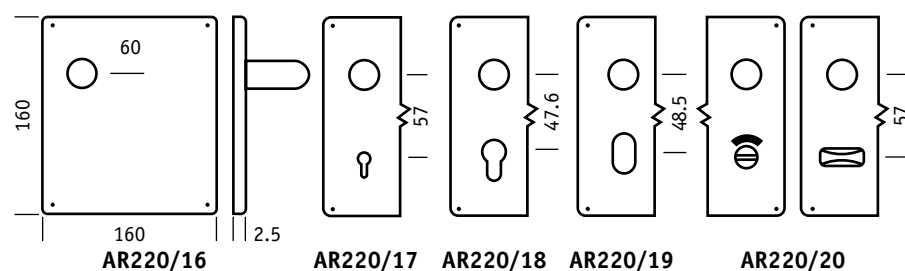

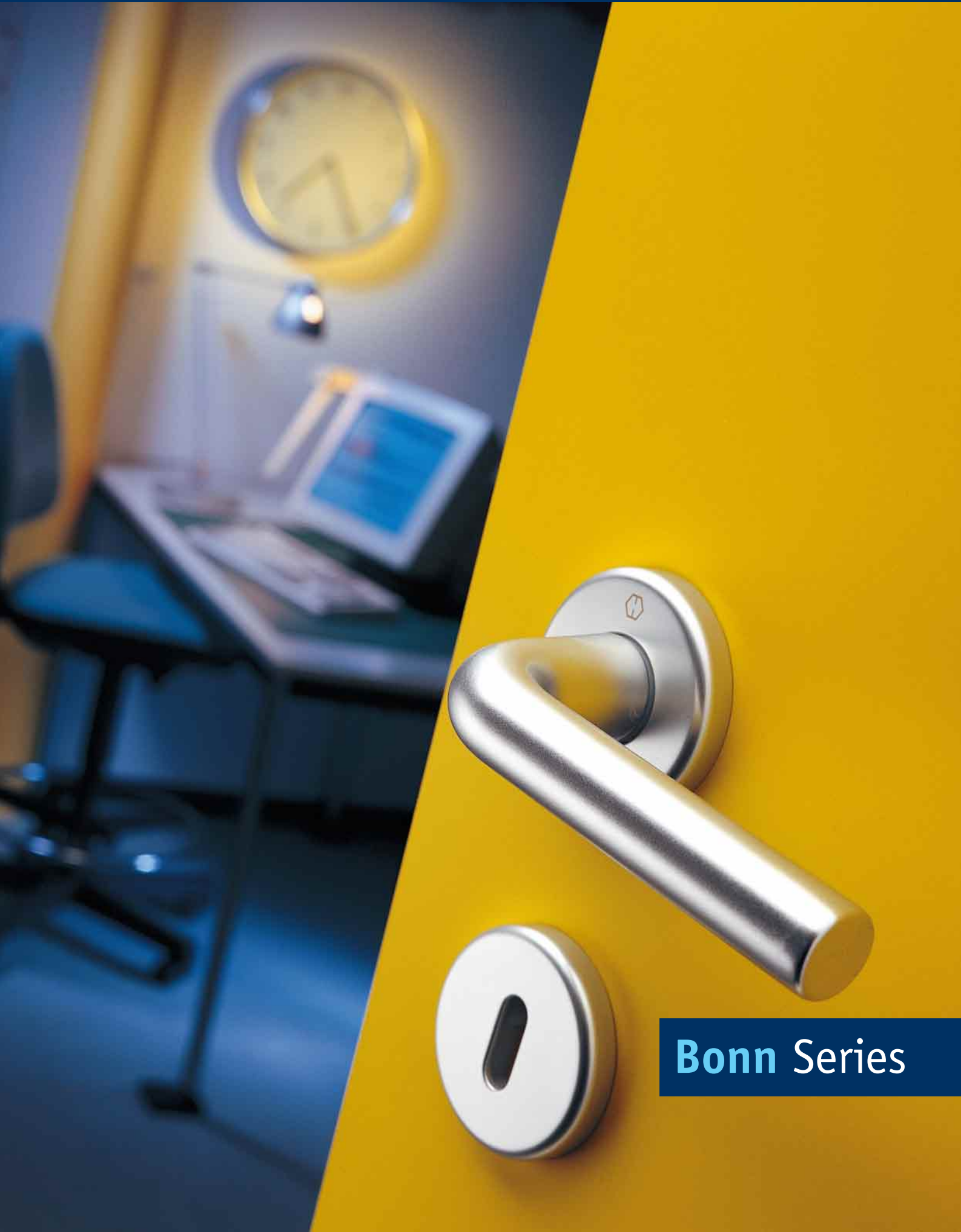

Bonn Series

Bonn Series

Levers on Round Rose : $\varnothing 20\text{mm}$

- AR230/10 supplied complete with bolt fixings & screws

AR230/10	20mm sprung lever on rose, 100mm split profile spindle Nylon understructure, 4 point fixing, 35mm to 50mm door thickness	SAA
AR230/10UN	20mm unsprung lever on rose, 100mm split profile spindle Nylon understructure, 2 point fixing, 35mm to 50mm door thickness	SAA

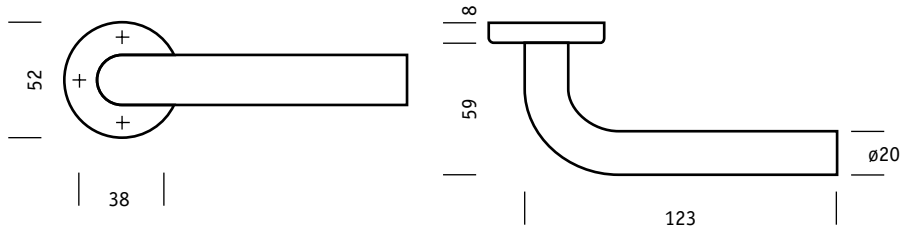

Concealed Fix Escutcheons

AR200/26	Lever key escutcheon 52mm diameter, 38mm fixing centres	SAA
AR200/27	Euro profile escutcheon 52mm diameter, 38mm fixing centres	SAA
AR200/28	Oval profile escutcheon 52mm diameter, 38mm fixing centres	SAA
AR200/30	Blind escutcheon 52mm diameter, 38mm fixing centres	SAA

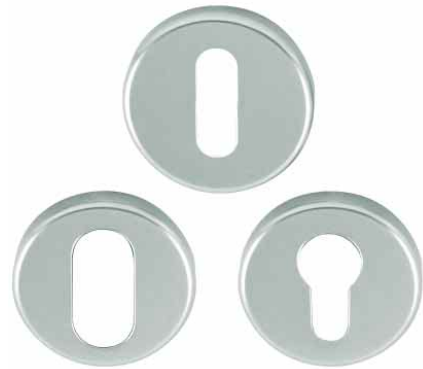
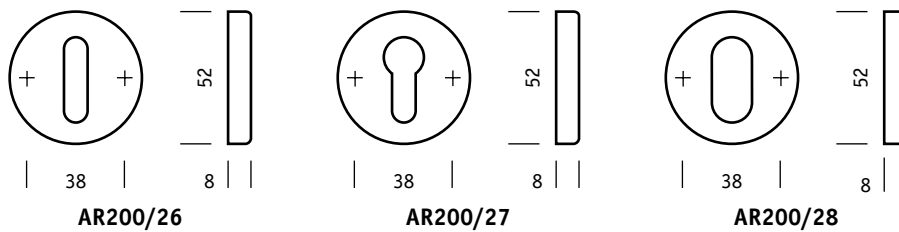

Bathroom Turn & Indicator

AR200/29	Bathroom turn & indicator 52mm diameter, 38mm fixing centres	SAA
AR200/29D	Disabled turn & indicator 52mm diameter, 38mm fixing centres	SAA

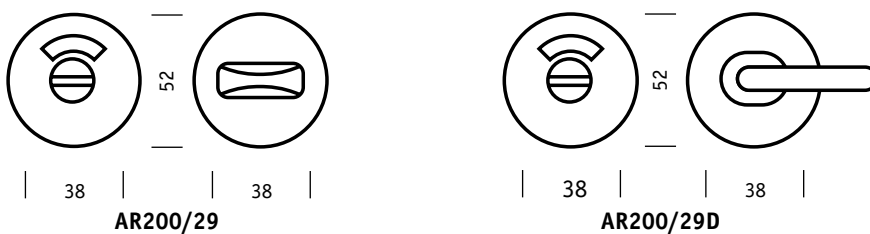

Levers on Concealed Fix Oblong Plate (sprung) : ø20mm

- 8mm x 105mm full profile spindle
- Suitable for 35mm to 50mm door thickness
- Supplied complete with bolt fixings

AR230/11	Long plate latch furniture	SAA
AR230/12	Lock furniture	SAA
AR230/13	Euro profile lock furniture	SAA
AR230/13G	Euro profile lock furniture for Guardian 51mm centres	SAA
AR230/14	Oval profile lock furniture	SAA
AR230/15	Bathroom furniture	SAA

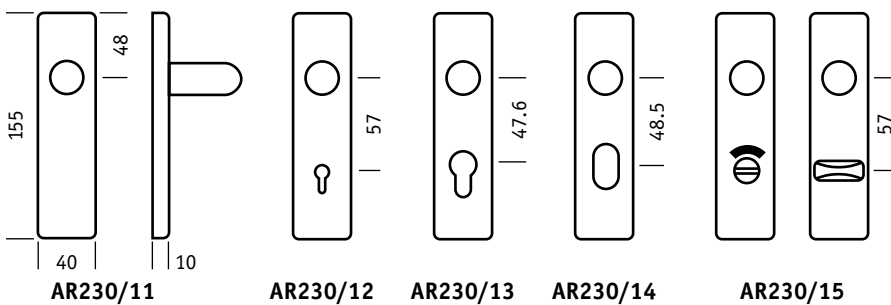

Levers on Concealed Fix Radius Plate (sprung) : ø20mm

- 8mm x 105mm full profile spindle
- Suitable for 35mm to 50mm door thickness
- Supplied complete with bolt fixings

AR230/31	Long plate latch furniture	SAA
AR230/32	Lock furniture	SAA
AR230/33	Euro profile lock furniture	SAA
AR230/33G	Euro profile lock furniture for Guardian 51mm centres	SAA
AR230/34	Oval profile lock furniture	SAA
AR230/35	Bathroom furniture	SAA

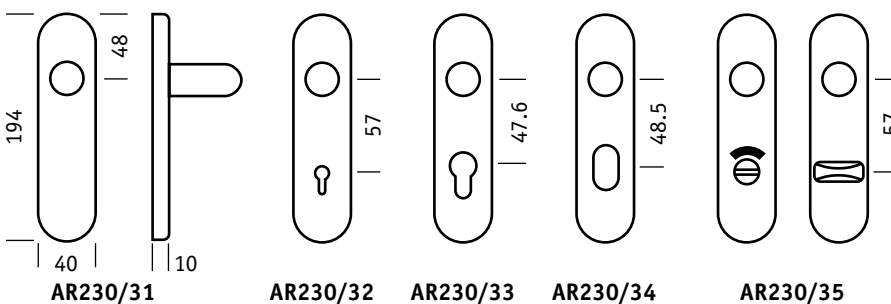

Bonn Series

Levers on 160mm x 64mm Face Fix Plate (unsprung) : ø20mm

- 8mm x 105mm full profile spindle
- Suitable for 35mm to 50mm door thickness

AR230/21	Long plate latch furniture	SAA
AR230/22	Lock furniture	SAA
AR230/23	Euro profile lock furniture	SAA
AR230/24	Oval profile lock furniture	SAA
AR230/25	Bathroom furniture	SAA

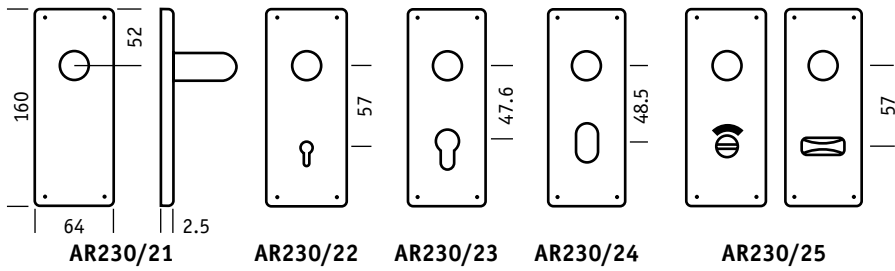

Levers on 160mm x 160mm Face Fix Plate (unsprung) : ø20mm

- 8mm x 105mm full profile spindle
- Suitable for 35mm to 50mm door thickness

AR230/16	Latch furniture	SAA
AR230/17	Lock furniture	SAA
AR230/18	Euro profile lock furniture	SAA
AR230/19	Oval profile lock furniture	SAA
AR230/20	Bathroom furniture (please state hand)	SAA

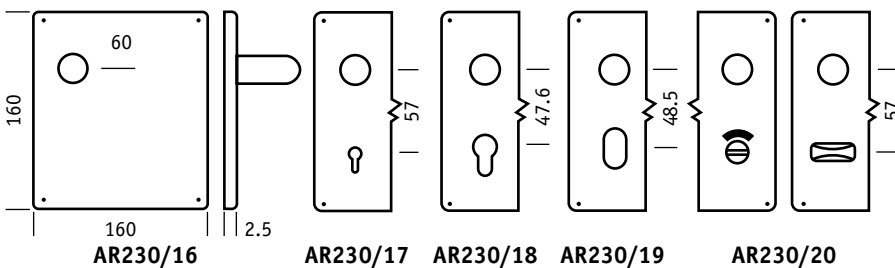



Pull Handles

Pull Handles

Straight Pull Handles : $\varnothing 20\text{mm}$

- Manufactured and designed to complement the extensive range of architectural aluminium furniture

AR202/H/150CF	150mm concealed screw fixing	SAA
AR202/H/225CF	225mm concealed screw fixing	SAA
AR202/H/300CF	300mm concealed screw fixing	SAA
AR202/H/425CF	425mm concealed screw fixing	SAA

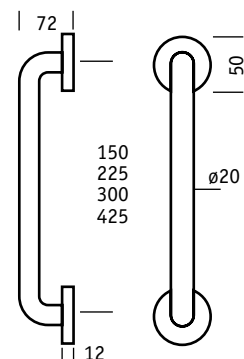
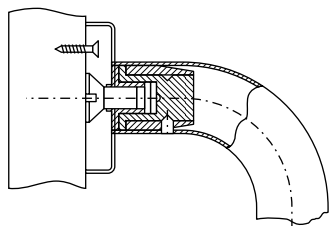

AR203/H/150BF	150mm bolt fixing	SAA
AR203/H/225BF	225mm bolt fixing	SAA
AR203/H/300BF	300mm bolt fixing	SAA
AR203/H/425BF	425mm bolt fixing	SAA

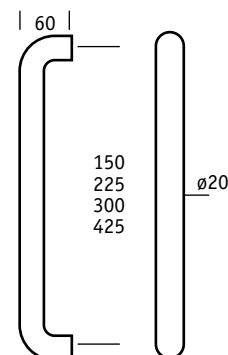
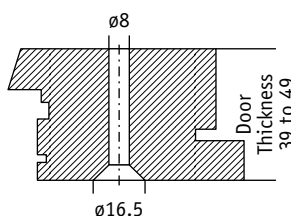
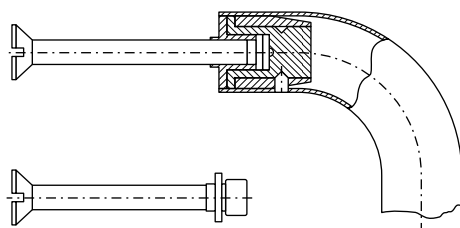

AR204/H/150BB	150mm back to back fixing	SAA
AR204/H/225BB	225mm back to back fixing	SAA
AR204/H/300BB	300mm back to back fixing	SAA
AR204/H/425BB	425mm back to back fixing	SAA

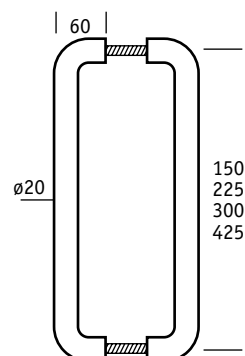
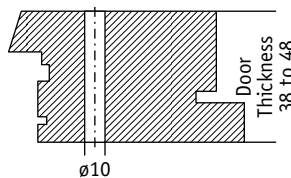
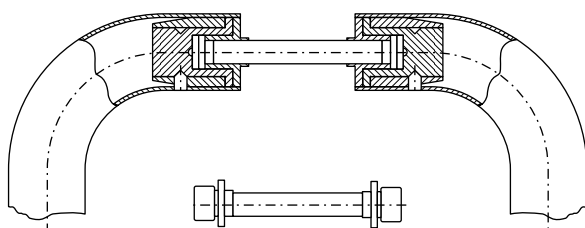

Straight Pull Handles : $\varnothing 22\text{mm}$

- Manufactured and designed to complement the extensive range of architectural aluminium furniture

AR222/150CF	150mm concealed screw fixing	SAA
AR222/225CF	225mm concealed screw fixing	SAA
AR222/300CF	300mm concealed screw fixing	SAA
AR222/425CF	425mm concealed screw fixing	SAA

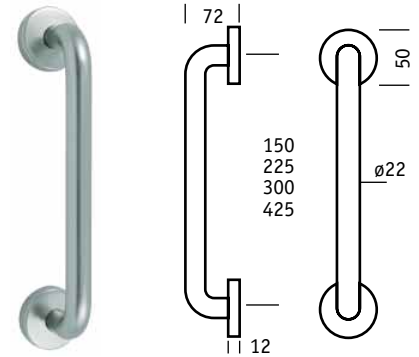
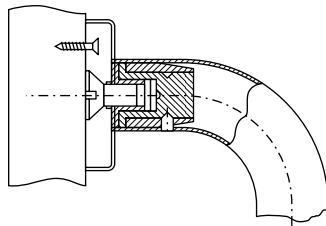

AR223/150BF	150mm bolt fixing	SAA
AR223/225BF	225mm bolt fixing	SAA
AR223/300BF	300mm bolt fixing	SAA
AR223/425BF	425mm bolt fixing	SAA

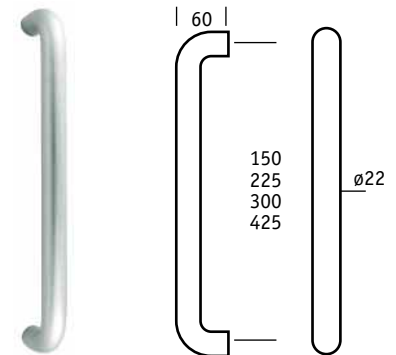
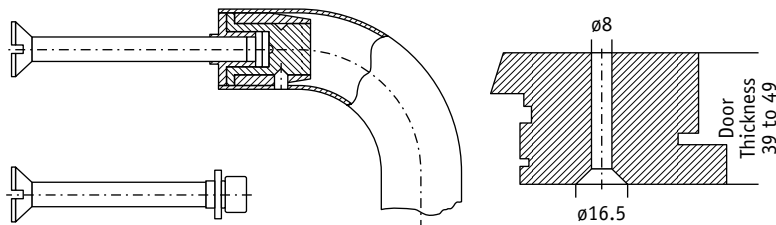

AR224/150BB	150mm back to back fixing	SAA
AR224/225BB	225mm back to back fixing	SAA
AR224/300BB	300mm back to back fixing	SAA
AR224/425BB	425mm back to back fixing	SAA

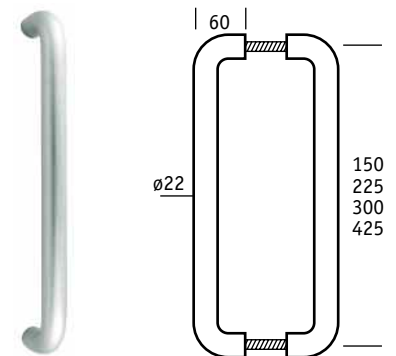
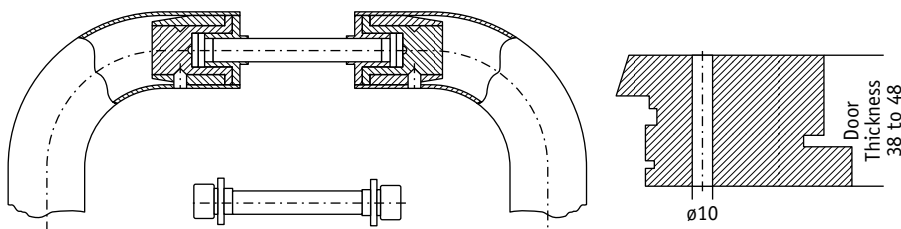

Pull Handles

Straight Pull Handles : $\varnothing 25\text{mm}$

- Manufactured and designed to complement the extensive range of architectural aluminium furniture

AR203/25/300BF	300mm bolt fixing	SAA
AR203/25/350BF	350mm bolt fixing	SAA

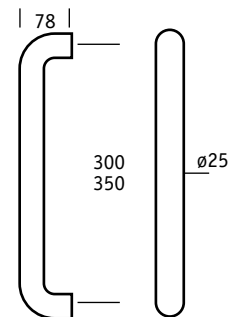
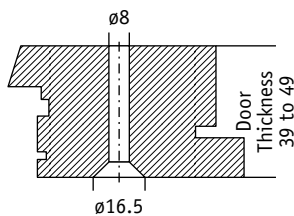
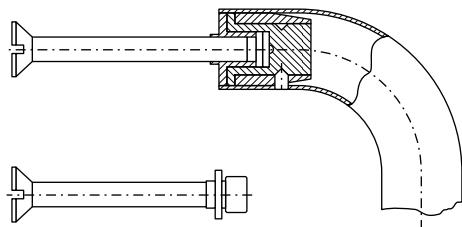

AR204/25/300BB	300mm back to back fixing	SAA
AR204/25/350BB	350mm back to back fixing	SAA

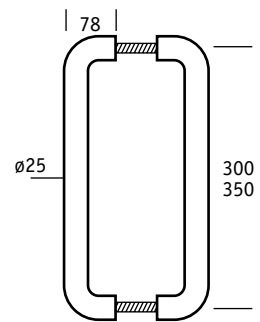
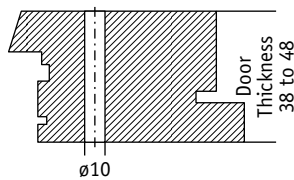
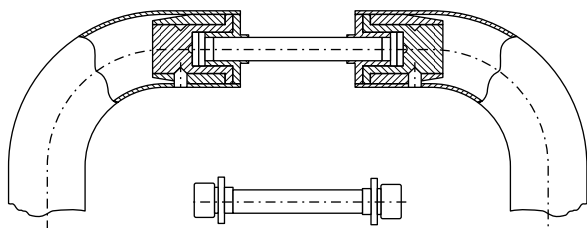

Straight Pull Handles : $\varnothing 30\text{mm}$

- Manufactured and designed to complement the extensive range of architectural aluminium furniture

AR203/30/300BF	300mm bolt fixing	SAA
AR203/30/350BF	350mm bolt fixing	SAA

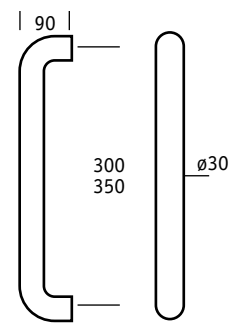
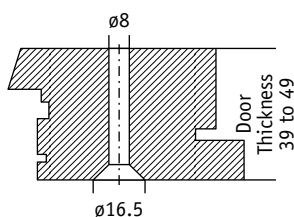
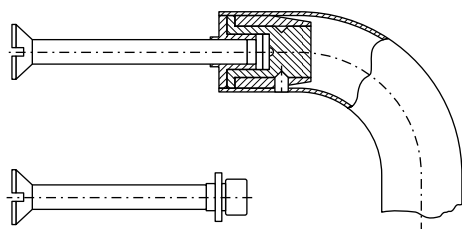

AR204/30/300BB	300mm back to back fixing	SAA
AR204/30/350BB	350mm back to back fixing	SAA

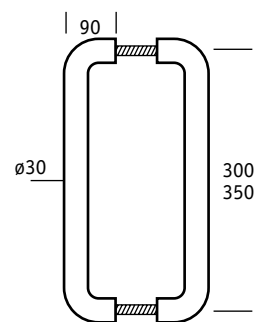
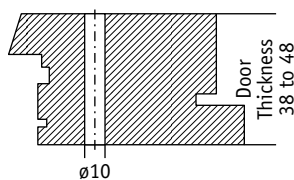
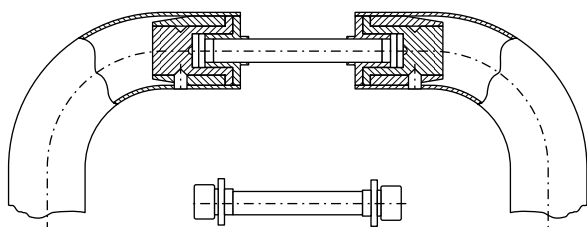

Cranked Pull Handles : $\varnothing 25\text{mm}$

- Manufactured and designed to complement the extensive range of architectural aluminium furniture

AR241/25/300BF	300mm bolt fixing	SAA
AR241/25/350BF	350mm bolt fixing	SAA

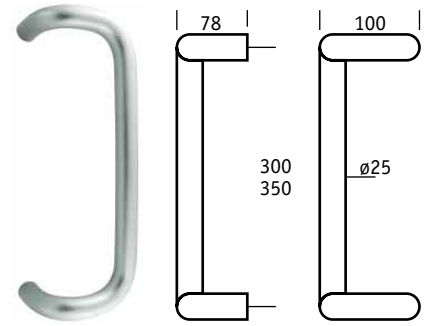
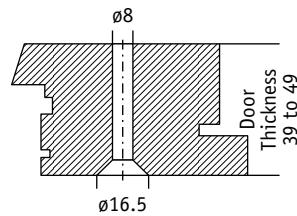
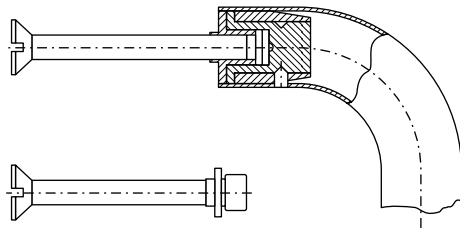

AR241/25/300BB	300mm back to back fixing	SAA
AR241/25/350BB	350mm back to back fixing	SAA

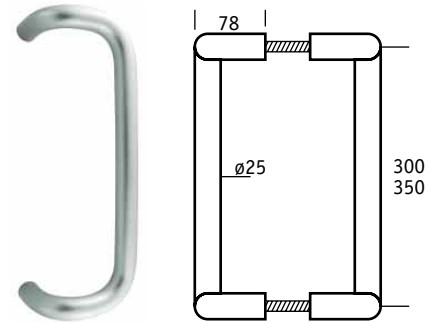
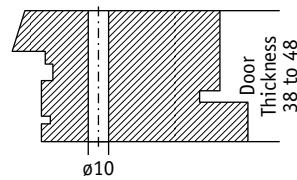
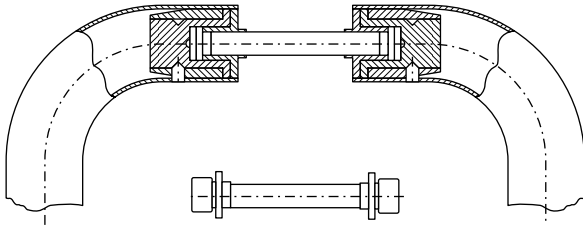

Cranked Pull Handles : $\varnothing 30\text{mm}$

- Manufactured and designed to complement the extensive range of architectural aluminium furniture

AR241/30/300BF	300mm bolt fixing	SAA
AR241/30/350BF	350mm bolt fixing	SAA

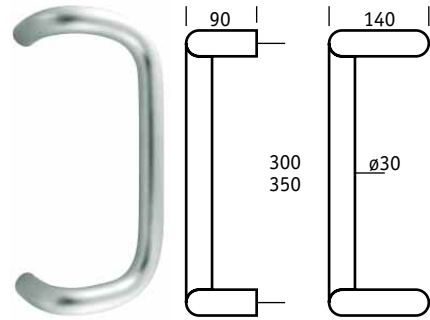
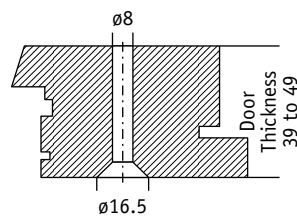
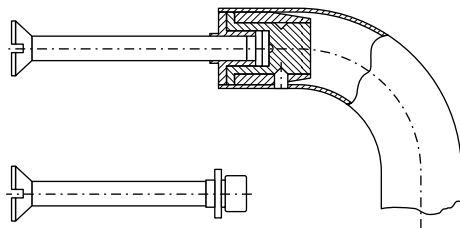

AR241/30/300BB	300mm back to back fixing	SAA
AR241/30/350BB	350mm back to back fixing	SAA

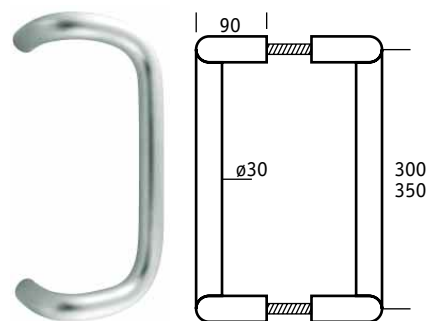
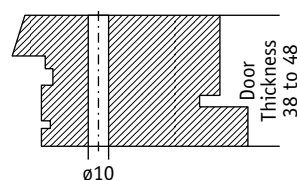
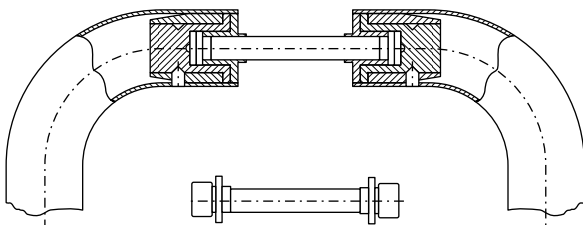

Pull Handles

Semi Circular Pull Handles : $\varnothing 25\text{mm}$

- Manufactured and designed to complement the extensive range of architectural aluminium furniture

AR242/25/200BF 200mm bolt fixing

SAA

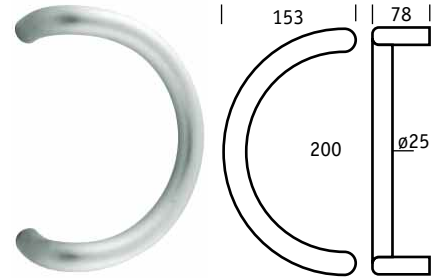
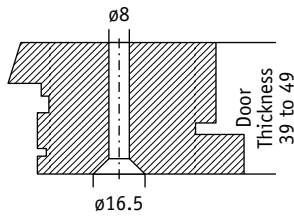
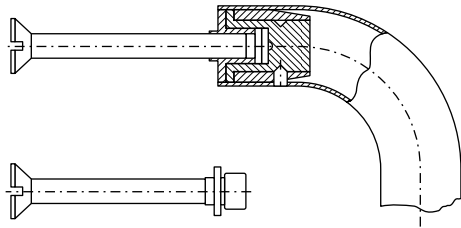

AR242/25/200BB 200mm back to back

SAA

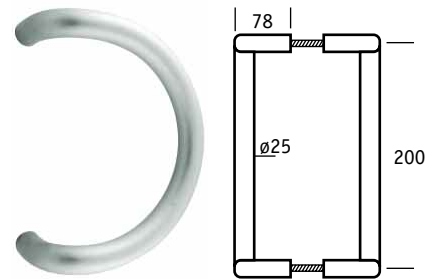
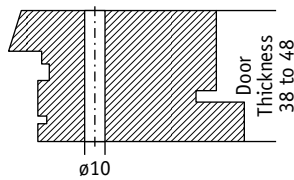
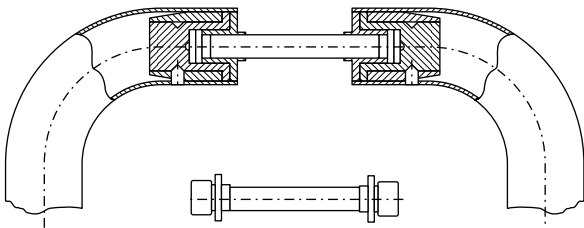

Semi Circular Pull Handles : $\varnothing 30\text{mm}$

- Manufactured and designed to complement the extensive range of architectural aluminium furniture

AR242/30/300BF 300mm bolt fixing

SAA

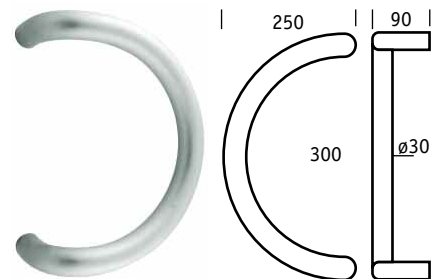
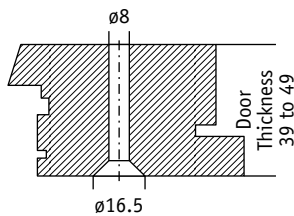
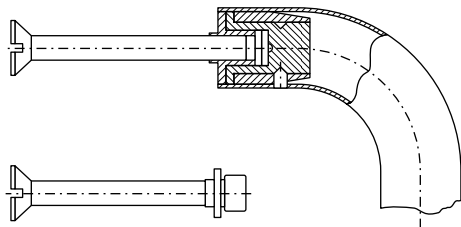

AR242/30/300BB 300mm back to back

SAA

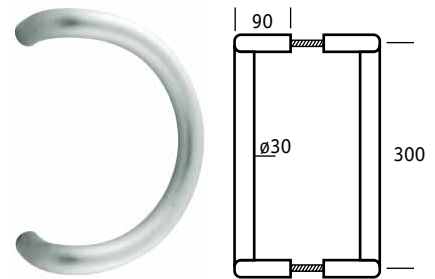
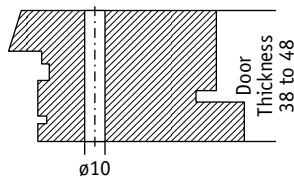
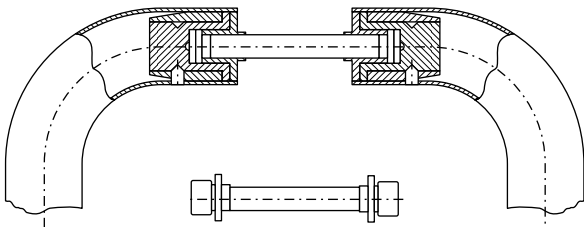

V Shaped Pull Handles : $\varnothing 25\text{mm}$

- Manufactured and designed to complement the extensive range of architectural aluminium furniture

AR271/25/300BF	300mm bolt fixing	SAA
AR271/25/350BF	350mm bolt fixing	SAA

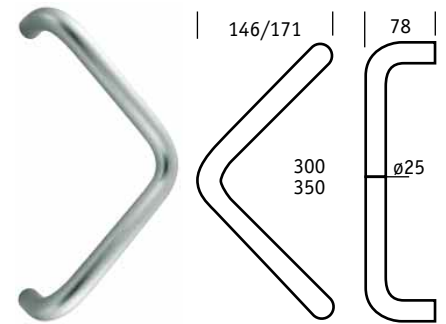
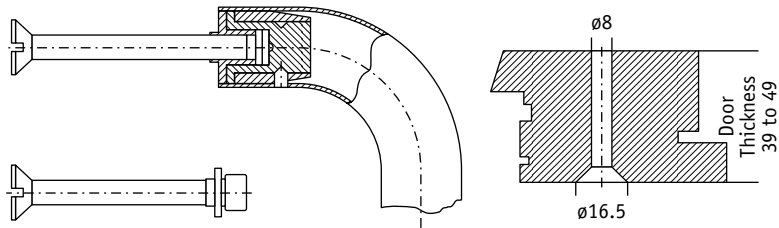

AR271/25/300BB	300mm back to back fixing	SAA
AR271/25/350BB	350mm back to back fixing	SAA

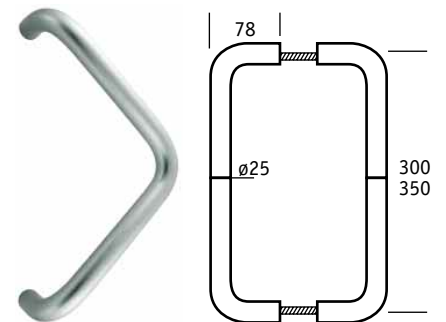
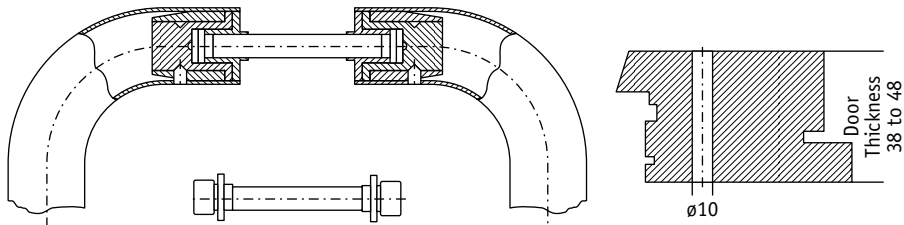

V Shaped Pull Handles : $\varnothing 30\text{mm}$

- Manufactured and designed to complement the extensive range of architectural aluminium furniture

AR271/30/300BF	300mm bolt fixing	SAA
AR271/30/350BF	350mm bolt fixing	SAA

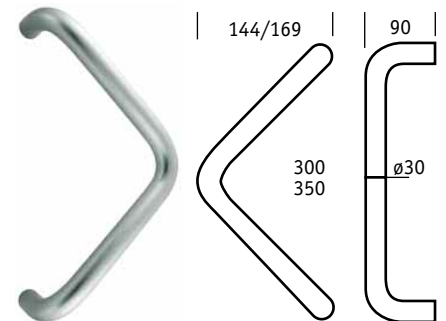
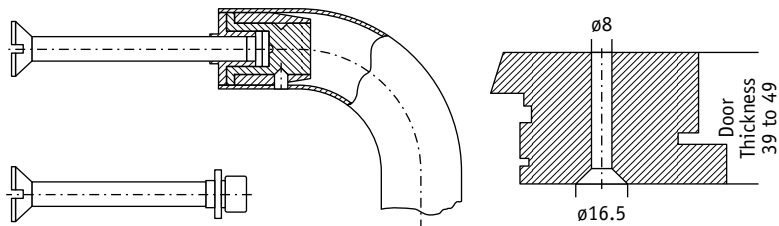

AR271/30/300BB	300mm back to back fixing	SAA
AR271/30/350BB	350mm back to back fixing	SAA

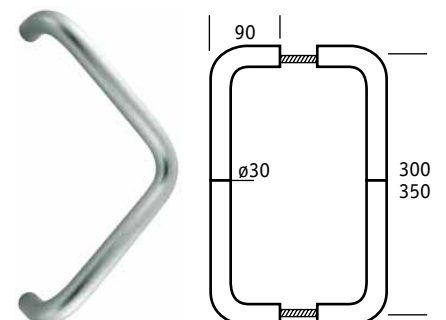
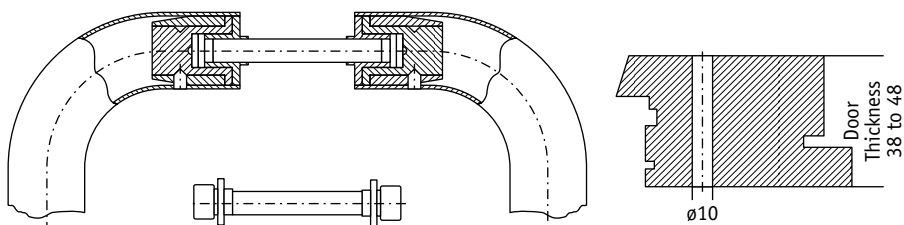

Accessories

Accessories

AR206S

Cylinder pull for standard rim cylinder

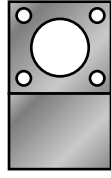

AR206YP

Cylinder pull for euro profile cylinder

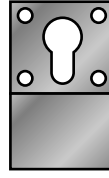

AR206U

Cylinder pull for union oval profile cylinder

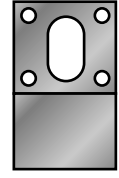

AR207M

155mm x 155mm square male wc sign



AR207F

155mm x 155mm square female wc sign

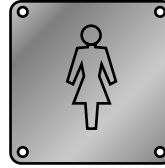

AR207D

155mm x 155mm square disabled wc sign



AR903MSAA

ø76mm circular male wc sign



AR903FSAA

ø76mm circular female wc sign

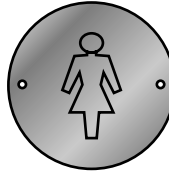

AR903DSAA

ø76mm circular disabled wc sign



AR900SAA

ø76mm circular keep locked shut sign



AR901SAA

ø76mm circular fire door keep locked sign



AR902SAA

ø76mm circular fire door keep shut sign



AR904SAA

80mm x 80mm square keep locked shut sign



AR905SAA

80mm x 80mm square fire door keep shut sign



AR906SAA

80mm x 80mm square fire door keep locked sign



AR907SAA

80mm x 80mm square fire door keep locked shut sign



AR208A

305mm x 100mm (aperture 250mm x 50mm) letter plate sprung flap



AR208B

354mm x 128mm (aperture 297mm x 76mm) letter plate sprung flap



AR208C

405mm x 128mm (aperture 347mm x 76mm) letter plate sprung flap



AR209A

254mm letter tidy



AR209B

305mm letter tidy



Accessories continued...

AR210A 150mm surface door bolt



AR210B 200mm surface door bolt



AR212 70mm door stop face fix on wall or skirting

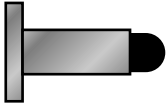

AR213 70mm door stop for wall or skirting



AR214 Door stop floor mounted
Please specify concrete or wood fixing



AR215 Bell push



AR217 Hat and coat hook

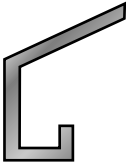

AR218 Buffered hat and coat hook

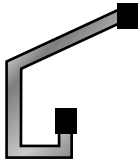

AR219 Wardrobe hook

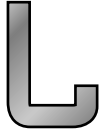

AR224A 75mm x 305mm finger plate square end drilled and countersunk



AR224B 75mm x 305mm finger plate radiused end drilled and countersunk



AR224C 75mm x 350mm finger plate square end drilled and countersunk



AR224D 75mm x 475mm finger plate square end drilled and countersunk



AR225 Kicking plates (cut to order)



AR226 Door selector
Successfully type tested to BS EN1158
Suitable for door closers of power sizes 3 to 5

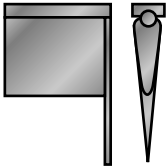

AR221A ø25mm cupboard knob



AR221B ø32mm cupboard knob



AR227 Handrail bracket 63mm projection



AR132A 19mm x 150mm flush bolt



AR132B 19mm x 200mm flush bolt



Accessories

Spindles and Accessories

06855-0105-0000

8mm x 105mm full profile spindle to suit doors up to 44mm thick



06850-2289-0000

8mm x 100mm split profile spindle to suit doors up to 44mm thick



06825-0889-0000

8mm x 60mm half spindle to suit doors up to 44mm thick



06855-2589-0000

8mm x 125mm full profile spindle to suit doors up to 54mm thick



06850-6289-0000

8mm x 120mm split profile spindle to suit doors up to 54mm thick



06885-1689-0000

8mm x 70mm half spindle to suit doors up to 54mm thick



AR228

8mm x 100mm spindle for split follower lock



07050-1789-0000

5mm x 75mm solid spindle for bathroom/privacy furniture



06860-1089-0000

Grub screw to suit full profile spindle



06862-5188-0000

Grub screw to suit split profile spindle



09610-0900-0000

Allen key to suit grub screws



AR200FP

Fixing pack of 2 bolt fixings and 4 screws



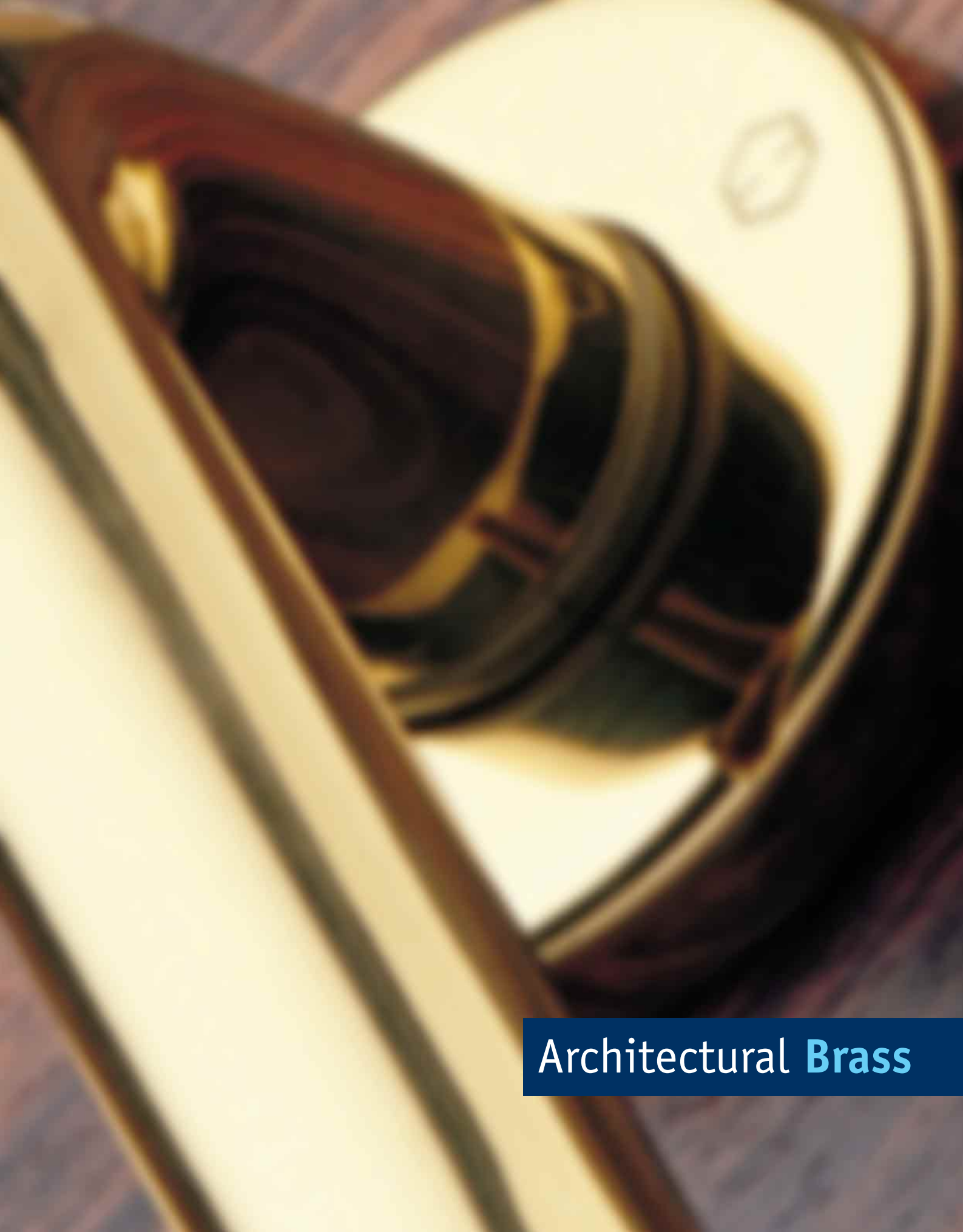

Architectural **Brass**

ARCHITECTURAL BRASS

Architectural Brass

HOPPE lever furniture and pull handles are manufactured using high quality brass. Lever furniture is lacquered using the electro-phoretic process, providing an excellent resistance to solvents and chemicals. **HOPPE** lever furniture carries a two year warranty against corrosion providing the cleaning instructions are strictly followed. Nonetheless, the use of aggressive cleaning agents should be avoided thus preventing damage to the surface which can result in corrosion. No special care is needed in everyday use; however, any dirt can be removed with a soft cloth and water.

HOPPE brass pull handles are waxed and not lacquered. Therefore, a natural patina (darkened brass) does develop after a while. Should this be undesirable the handles can be periodically repolished.

Pull handles are available in concealed screw fix, bolt fix or back to back fixing.

Consideration should be given to the use of the handle and bolt fixing or back to back fixing, should be specified in high use situations.

HOPPE brass door furniture is designed to provide the highest quality at an attractive price - performance ratio.



Verona Series

Verona Series

Levers on Round Rose

- Supplied with bolt through and woodscrew fixings
- Lever is fixed to spindle on outside for security (on unsprung only)

AR410/30	Sprung lever on rose, 105mm split profile spindle Nylon understructure, 35mm to 50mm door thickness	PB
AR410/30UN	Unsprung lever on rose, 105mm split profile spindle Nylon understructure, 35mm to 50mm door thickness	PB

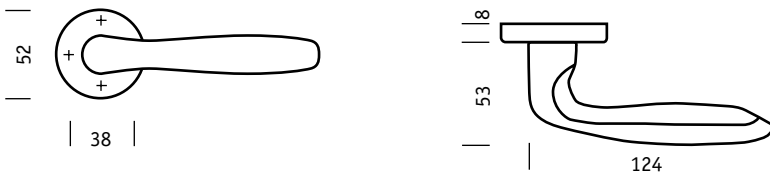

Concealed Fix Escutcheons

- Pressed brass cover with plastic inner plate

AR490/36	Lever key escutcheon 52mm diameter, 38mm fixing centres	PB
AR490/37	Euro profile escutcheon 52mm diameter, 38mm fixing centres	PB
AR490/38	Oval profile escutcheon 52mm diameter, 38mm fixing centres	PB

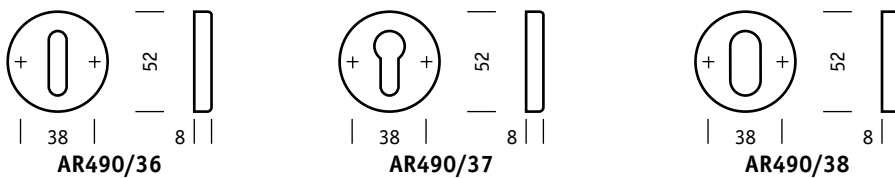

Turn & Indicator

AR490/39	Bathroom turn & emergency release, 5mm spindle 52mm diameter, 38mm fixing centres	PB
AR490/39D	Disabled turn & indicator, 5mm spindle 52mm diameter, 38mm fixing centres	PB



Levers on Concealed Fix Radius Plate (unsprung)

- Supplied with 105mm split profile spindle
- Cast brass coverplate with internal nylon backplate
- Suitable 35mm to 50mm door thickness

AR410/31	Latch furniture	PB
AR410/32	Lock furniture	PB
AR410/33	Euro profile lock furniture	PB
AR410/34	Oval profile lock furniture	PB
AR410/35	Bathroom furniture	PB

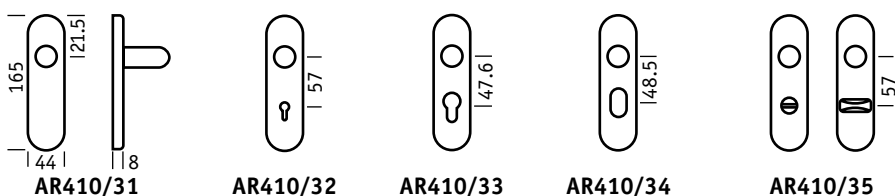



Paris Series

Paris Series

Levers on Round Rose : $\varnothing 19\text{mm}$

- Supplied with bolt through and woodscrew fixings
- Lever is fixed to spindle on outside for security (on unsprung version)

AR420/30	19mm sprung lever on rose, 105mm split profile Nylon understructure, 35mm to 50mm door thickness	PB
AR420/30UN	19mm unsprung lever on rose, 105mm split profile Nylon understructure, 35mm to 50mm door thickness	PB

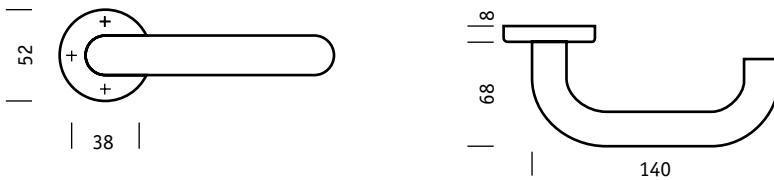

Concealed Fix Escutcheons

- Pressed brass cover with plastic inner plate

AR490/36	Lever key escutcheon 52mm diameter, 38mm fixing centres	PB
AR490/37	Euro profile escutcheon 52mm diameter, 38mm fixing centres	PB
AR490/38	Oval profile escutcheon 52mm diameter, 38mm fixing centres	PB

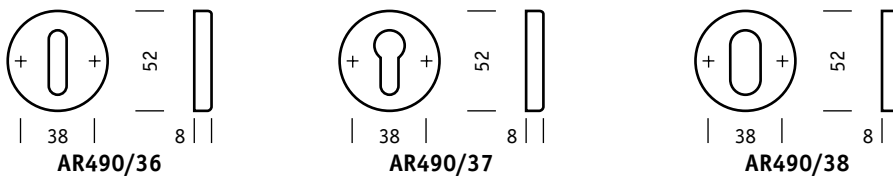

Turn & Indicator

AR490/39	Bathroom turn & emergency release, 5mm spindle 52mm diameter, 38mm fixing centres	PB
AR490/39D	Disabled turn & indicator, 5mm spindle 52mm diameter, 38mm fixing centres	PB



Levers on Concealed Fix Radius Plate (unsprung) : $\varnothing 19\text{mm}$

- Supplied with 105mm split profile spindle
- Cast brass coverplate with internal nylon backplate
- Suitable 35mm to 50mm door thickness

AR420/31	Latch furniture	PB
AR420/32	Lock furniture	PB
AR420/33	Euro profile lock furniture	PB
AR420/34	Oval profile lock furniture	PB
AR420/35	Bathroom furniture	PB





Barcelona Series

Barcelona Series

Levers on Round Rose

- Supplied with bolt through and woodscrew fixings
- Lever is fixed to spindle on outside for security (on unsprung only)

AR480/30	Sprung lever on rose, 105mm split profile spindle Nylon understructure, 35mm to 50mm door thickness	PB
AR480/30UN	Unsprung lever on rose, 105mm split profile spindle Nylon understructure, 35mm to 50mm door thickness	PB

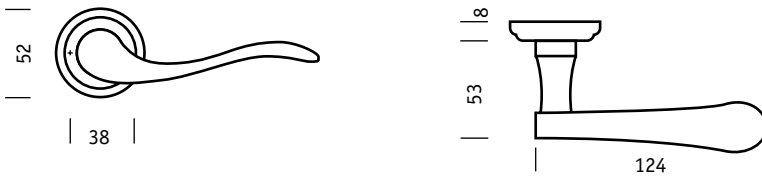

Concealed Fix Escutcheons

- Pressed brass cover with plastic inner plate

AR490/36	Lever key escutcheon 52mm diameter, 38mm fixing centres	PB
AR490/37	Euro profile escutcheon 52mm diameter, 38mm fixing centres	PB
AR490/38	Oval profile escutcheon 52mm diameter, 38mm fixing centres	PB

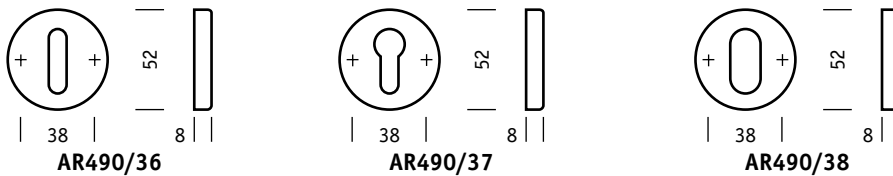

Turn & Indicator

AR490/39	Bathroom turn & emergency release, 5mm spindle 52mm diameter, 38mm fixing centres	PB
AR490/39D	Disabled turn & indicator, 5mm spindle 52mm diameter, 38mm fixing centres	PB



Levers on Concealed Fix Radius Plate (unsprung)

- Supplied with 105mm split profile spindle
- Cast brass coverplate with internal nylon backplate
- Suitable 35mm to 50mm door thickness

AR480/31	Latch furniture	PB
AR480/32	Lock furniture	PB
AR480/33	Euro profile lock furniture	PB
AR480/34	Oval profile lock furniture	PB
AR480/35	Bathroom furniture	PB

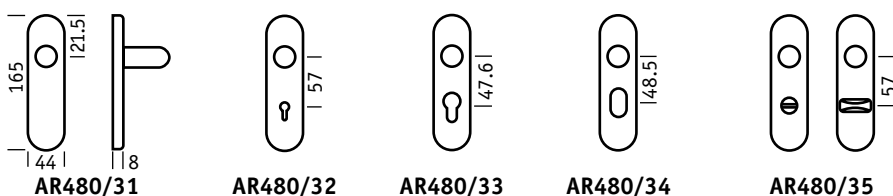



Vienna Series

Vienna Series

Levers on Round Rose

- Supplied with bolt through and woodscrew fixings
- Lever is fixed to spindle on outside for security (on unsprung only)

AR470/30	20mm sprung lever on rose, 105mm split profile spindle Nylon understructure, 35mm to 50mm door thickness	PB
AR470/30UN	Unsprung lever on rose, 105mm split profile spindle Nylon understructure, 35mm to 50mm door thickness	PB



Concealed Fix Escutcheons

- Pressed brass cover with plastic inner plate

AR490/36	Lever key escutcheon 52mm diameter, 38mm fixing centres	PB
AR490/37	Euro profile escutcheon 52mm diameter, 38mm fixing centres	PB
AR490/38	Oval profile escutcheon 52mm diameter, 38mm fixing centres	PB

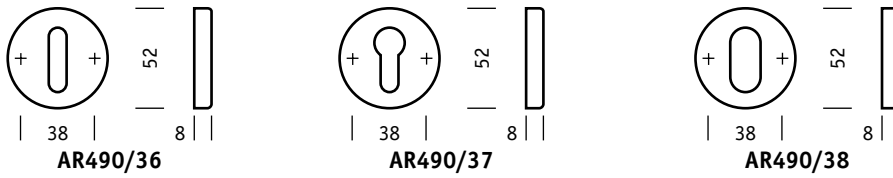

Turn & Indicator

AR490/39	Bathroom turn & emergency release, 5mm spindle 52mm diameter, 38mm fixing centres	PB
AR490/39D	Disabled turn & indicator, 5mm spindle 52mm diameter, 38mm fixing centres	PB

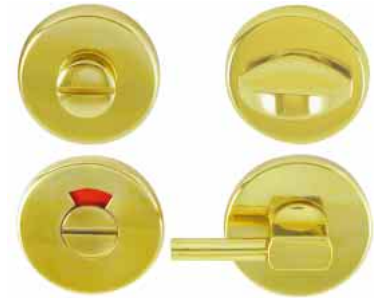

Levers on Concealed Fix Radius Plate (unsprung)

- Supplied with 105mm split profile spindle
- Cast brass coverplate with internal nylon backplate
- Suitable 35mm to 50mm door thickness

AR470/31	Latch furniture	PB
AR470/32	Lock furniture	PB
AR470/33	Euro profile lock furniture	PB
AR470/34	Oval profile lock furniture	PB
AR470/35	Bathroom furniture	PB





Pull Handles

Pull Handles

Straight Pull Handles : $\varnothing 19\text{mm}$

AR402/150CF	150mm concealed screw fixing	PB
AR402/225CF	225mm concealed screw fixing	PB
AR402/300CF	300mm concealed screw fixing	PB

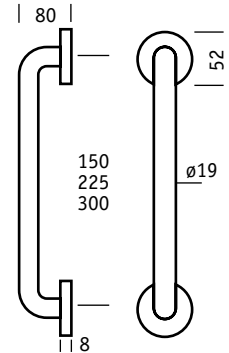
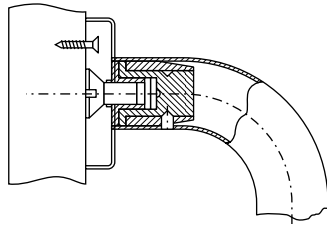

AR403/150BF	150mm bolt fixing	PB
AR403/225BF	225mm bolt fixing	PB
AR403/300BF	300mm bolt fixing	PB

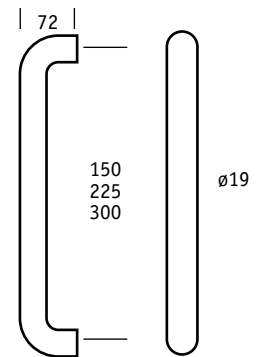
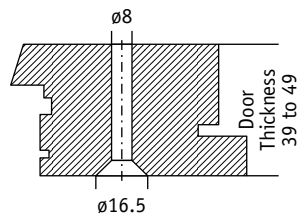
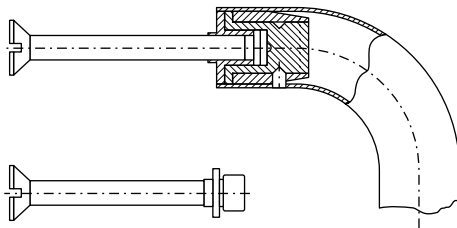

AR404/150BB	150mm back to back fixing	PB
AR404/225BB	225mm back to back fixing	PB
AR404/300BB	300mm back to back fixing	PB

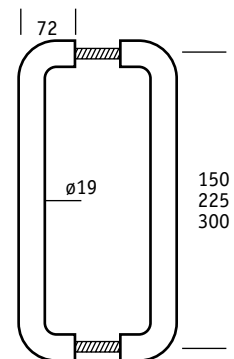
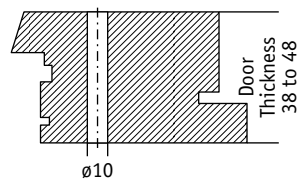
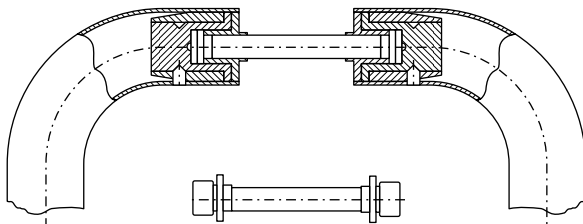

Straight Pull Handles : $\varnothing 25\text{mm}$

AR403/25/300BF	300mm bolt fixing	PB
AR403/25/350BF	350mm bolt fixing	PB

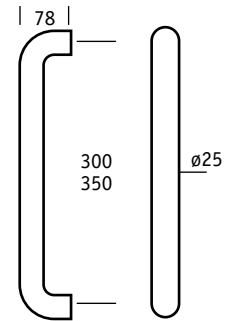
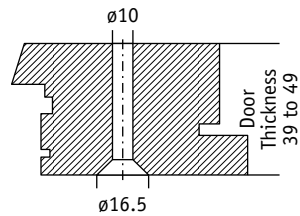
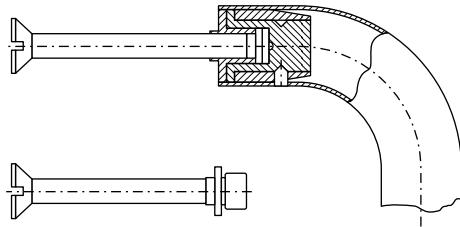

AR404/25/300BB	300mm back to back fixing	PB
AR404/25/350BB	350mm back to back fixing	PB

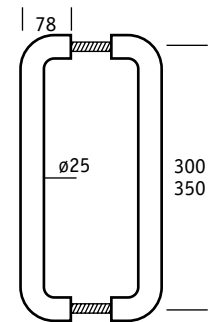
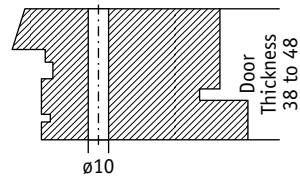
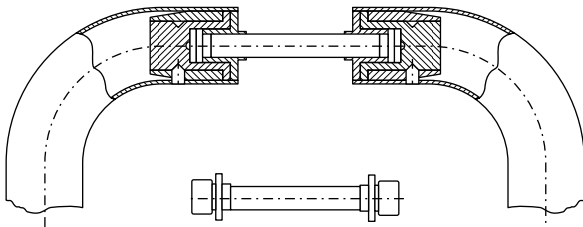

Straight Pull Handles : $\varnothing 30\text{mm}$

AR403/30/300BF	300mm bolt fixing	PB
AR403/30/350BF	350mm bolt fixing	PB

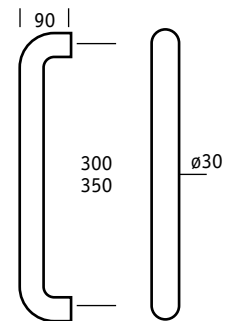
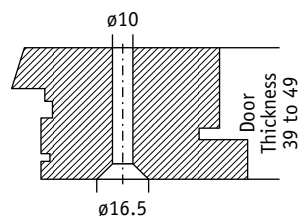
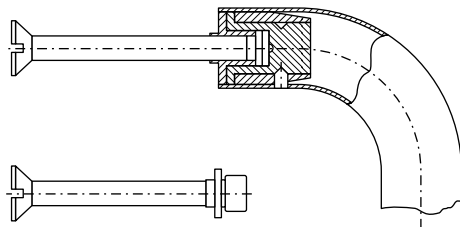

AR404/30/300BB	300mm back to back fixing	PB
AR404/30/350BB	350mm back to back fixing	PB

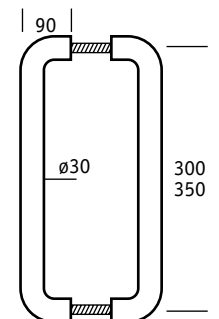
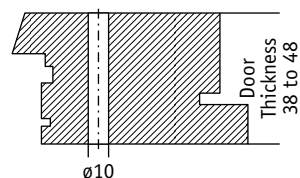
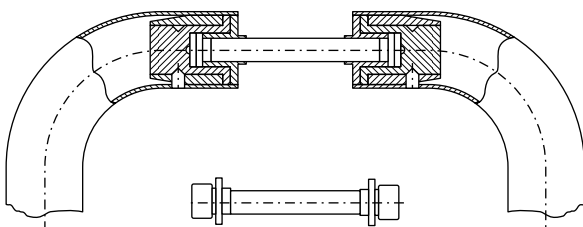

Pull Handles

Cranked Pull Handles : $\varnothing 25\text{mm}$

AR440/25/300BF	300mm bolt fixing	PB
AR440/25/350BF	350mm bolt fixing	PB

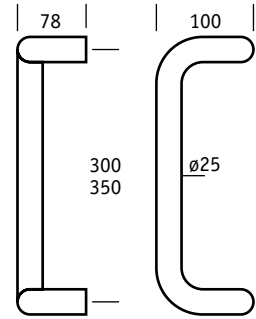
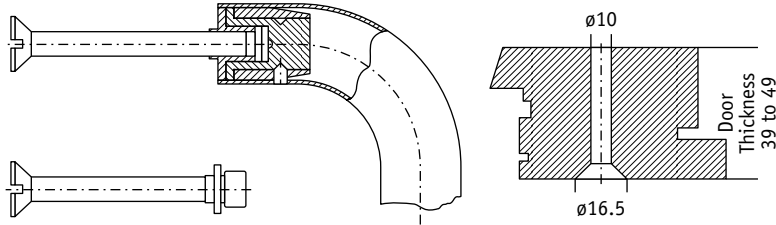

AR441/25/300BB	300mm back to back fixing	PB
AR441/25/350BB	350mm back to back fixing	PB

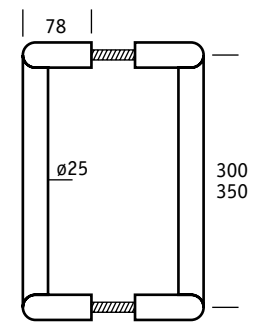
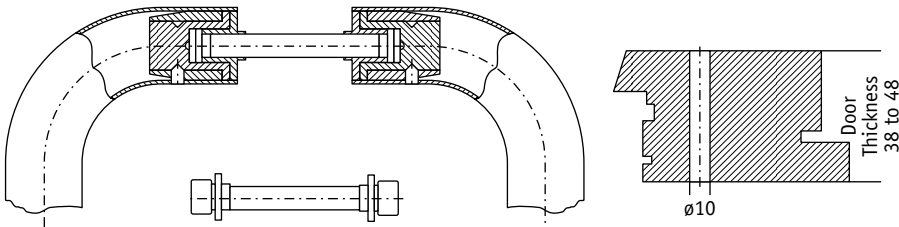

Cranked Pull Handles : $\varnothing 30\text{mm}$

AR440/30/300BF	300mm bolt fixing	PB
AR440/30/350BF	350mm bolt fixing	PB

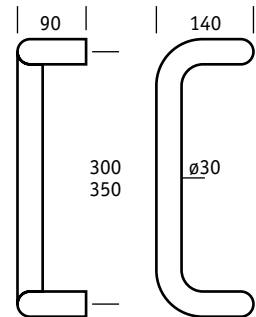
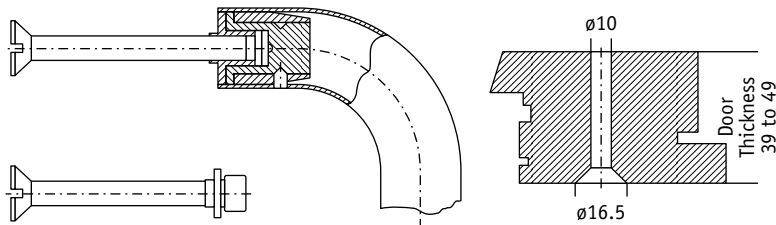

AR441/30/300BB	300mm back to back fixing	PB
AR441/30/350BB	350mm back to back fixing	PB

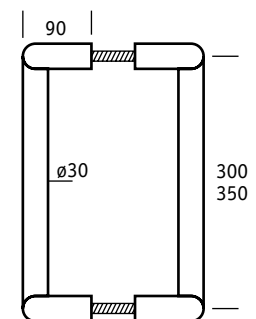
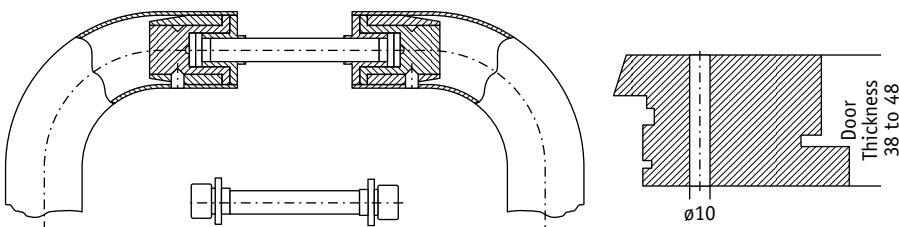

Semi Circular Pull Handles : $\varnothing 25\text{mm}$

AR442/25/200BF

200mm bolt fixing

PB

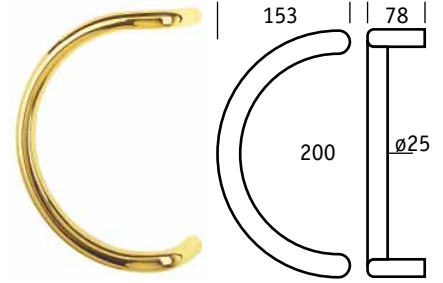
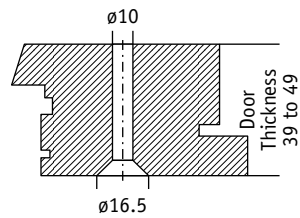
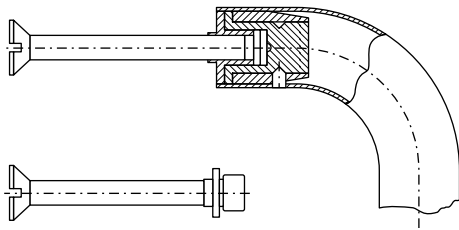

AR443/25/200BB

200mm back to back

PB

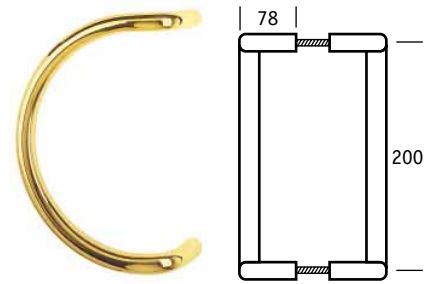
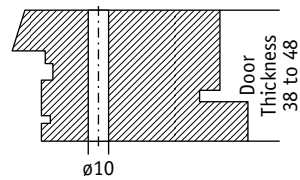
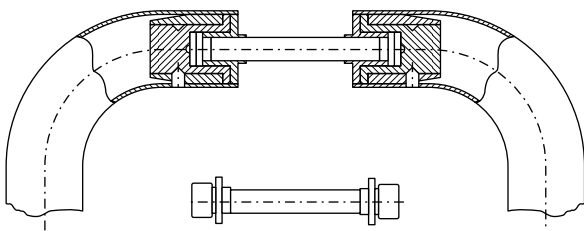

Semi Circular Pull Handles : $\varnothing 30\text{mm}$

AR442/30/350BF

350mm bolt fixing

PB

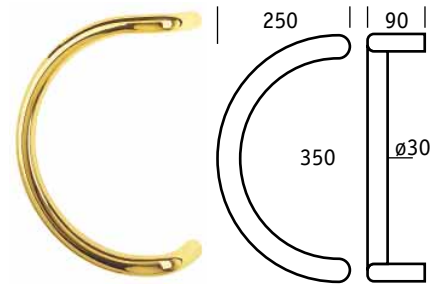
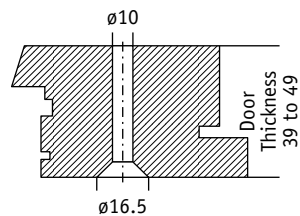
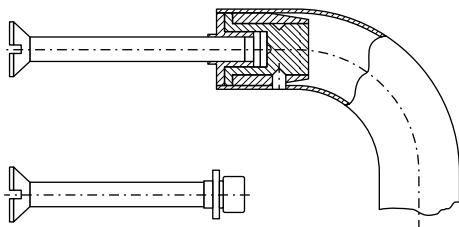

AR443/30/350BB

350mm back to back

PB

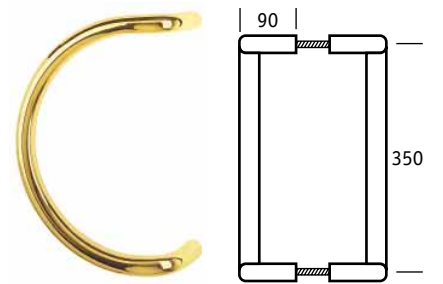
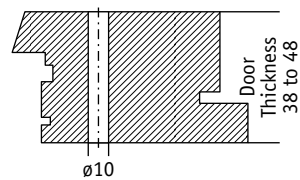
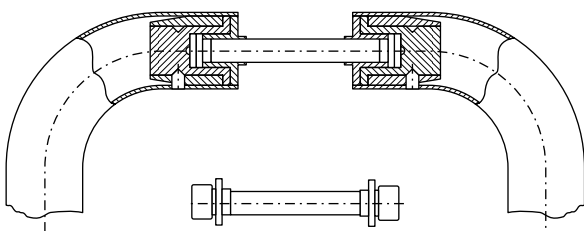

Pull Handles

V Shaped Pull Handles : $\varnothing 25\text{mm}$

AR470/25/300BF	300mm bolt fixing	PB
AR470/25/350BF	350mm bolt fixing	PB

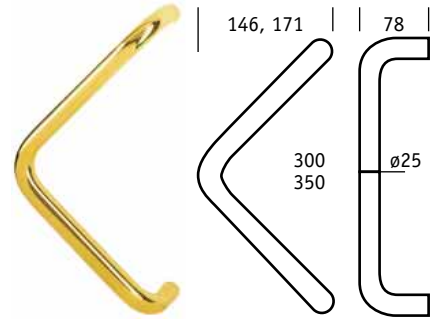
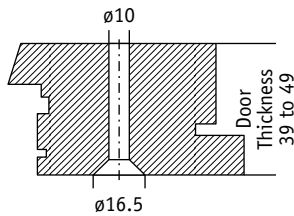
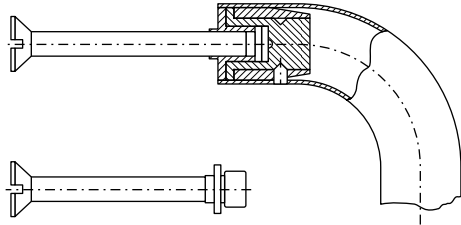

AR471/25/300BB	300mm back to back fixing	PB
AR471/25/350BB	350mm back to back fixing	PB

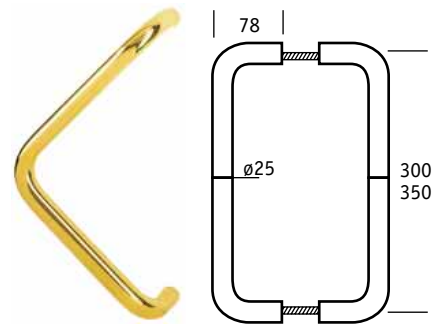
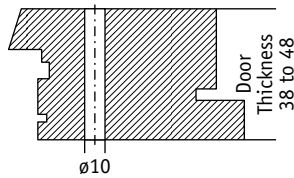
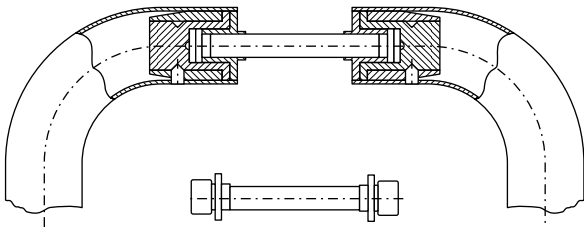

V Shaped Pull Handles : $\varnothing 30\text{mm}$



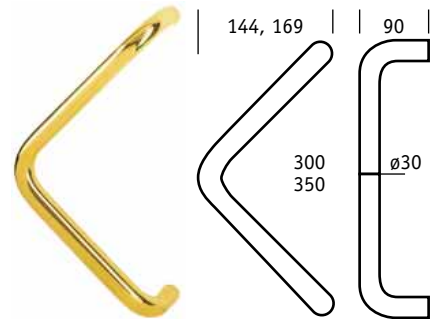
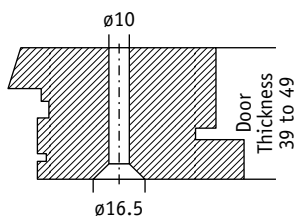
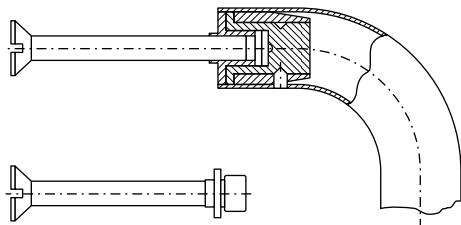



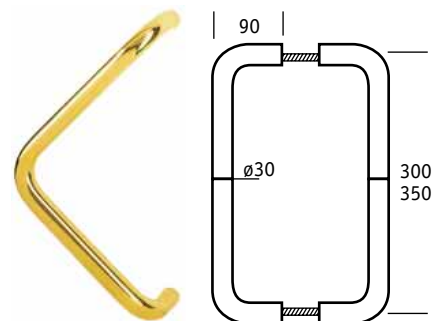
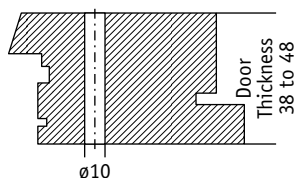
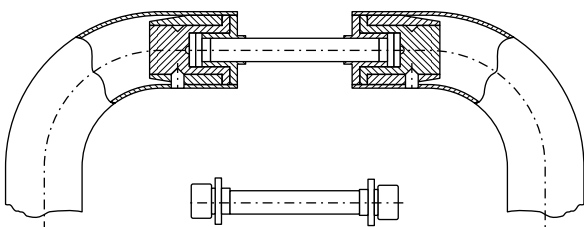



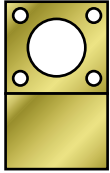
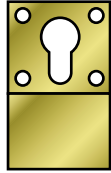
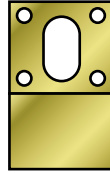



AR470/30/300BF	300mm bolt fixing	PB
AR470/30/350BF	350mm bolt fixing	PB



AR471/30/300BB	300mm back to back fixing	PB
AR471/30/350BB	350mm back to back fixing	PB

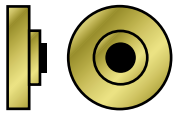
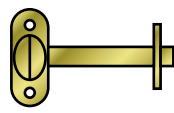
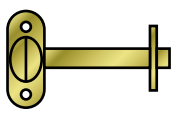
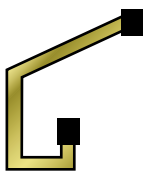
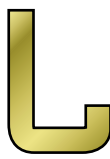
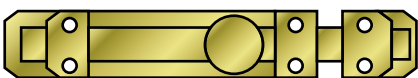
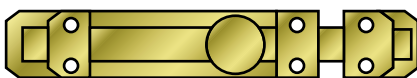
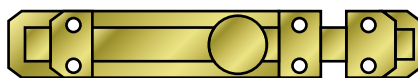

Accessories

<p>AR406S Cylinder pull for standard rim cylinder</p>		<p>AR406YP Cylinder pull for euro profile cylinder</p>		<p>AR406U Cylinder pull for union oval profile cylinder</p>	
<p>AR903MPB ø76mm circular male wc sign</p>		<p>AR903FPB ø76mm circular female wc sign</p>		<p>AR903DPB ø76mm circular disabled wc sign</p>	
<p>AR908MPB 150mm x 100mm oblong male wc sign</p>		<p>AR908FPB 150mm x 100mm oblong female wc sign</p>		<p>AR908DPB 150mm x 100mm oblong disabled wc sign</p>	
<p>AR900PB ø76mm circular keep locked shut sign</p>		<p>AR901PB ø76mm circular fire door keep locked sign</p>		<p>AR902PB ø76mm circular fire door keep shut sign</p>	
<p>AR904PB 80mm x 80mm square keep locked shut sign</p>		<p>AR905PB 80mm x 80mm square fire door keep shut sign</p>		<p>AR906PB 80mm x 80mm square fire door keep locked sign</p>	
<p>AR907PB 80mm x 80mm square fire door keep locked shut sign</p>		<p>AR415 ø53mm bell push</p>		<p>AR416 Rack bolt with thumb turn & coin release</p>	
<p>AR416A Rack bolt with thumb turn</p>		<p>AR418 Buffered hat & coat hook</p>		<p>AR419 Wardrobe hook</p>	
<p>AR421A 152mm x 35mm door bolt surface mounted</p>		<p>AR421B 203mm x 42mm door bolt surface mounted</p>		<p>AR421C 254mm x 43mm door bolt surface mounted</p>	

Accessories

Accessories continued...

AR428A

152mm x 19mm
flush bolt
lever action



A428B

203mm x 19mm
flush bolt
lever action

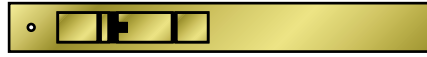

AR422

Espagnolette bolt



AR422A

Extra shoot guides

AR422B

Angled striker plates

AR422C

Extra shoots

AR424A

300mm x 75mm
finger plate
drilled and countersunk



AR424B

350mm x 75mm
finger plate
drilled and countersunk



AR424C

350mm x 75mm
finger plate
printed "push"
drilled and countersunk



AR424D

350mm x 75mm
finger plate
engraved "push"
drilled and countersunk



AR424E

305mm x 75mm
finger plate radiused
drilled and countersunk



AR425

Kicking plates
(cut to order)



AR426A

305mm x 102mm overall
227mm x 50mm aperture
letter plate
sprung flap



AR426B

305mm x 127mm overall
293mm x 68mm aperture
letter plate
sprung flap



AR426C

406mm x 127mm overall
316mm x 64mm aperture
letter plate
sprung flap



AR426D

280mm inner flap



AR426E

295mm inner flap



AR427A

35mm door stop body

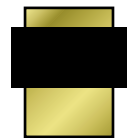

AR427B

75mm door stop
concealed rose



AR427C

75mm door stop
secret fixing



AR427D

Door stop oval
shielded body



AR539A

Door stop circular
shielded suitable
for screw down or
concrete in



ARRONE

Overhead Door Closers

Overhead Door Closers

ARRONE Door Controls satisfy a comprehensive range of applications from a light duty contract unit through to high performance architectural units suitable for the most prestigious of projects, all available in standard and metal finishes along with 11 RAL colours where applicable.

When selecting a door closer for your project particular attention should be paid to the choice of unit ensuring the correct power size, application and standard is selected. To assist with this selection process please refer to information and selector pages.

Performance

In accordance with BS EN1154

Power Size	Max Door Width	Max Door Weight
2(A)	850mm	40kg
3(B)	950mm	60kg
4	1100mm	80kg
5	1250mm	100kg
6	1400mm	120kg

(A) Not to be used on fire resisting doorsets.

(B) Not recommended for fig 66 application on fire resisting doorsets, size 4 should be used

Fig 1 Application

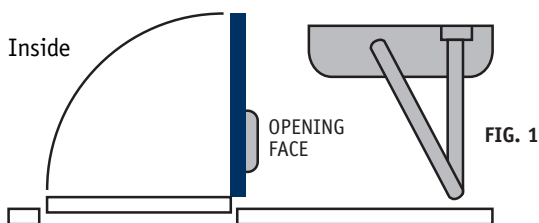

Door Closer mounted on 'Pull' side of door leaf

Fig 66 Application

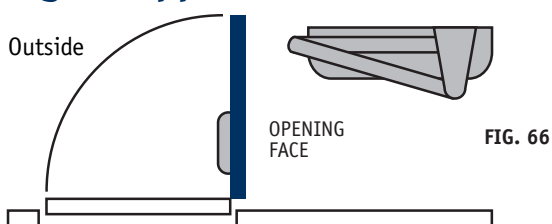

Door closer mounted on 'Push' side of door leaf using fig. 66 bracket.

Notes: Mounting a door closer in fig. 66 application effectively reduces power size by ONE. It is therefore recommended in accordance with BS EN1154 that a minimum size 4 door closer is fitted when this application is required.

Slide Arm Application

Can be used where it is undesirable to have a projecting arm. Consists of single arm connected to channel mounted above the door (not suitable for doors with projecting architraves) NB. Minimum power size 4 is recommended as per BS EN1154 due to reduction of power in this application.

Door Stops

Wherever possible a door stop should be fitted when using door closer devices

Door Closers Finishes and Colours



Silver



Gold



Polished Brass



Polished & Satin Stainless Steel/Chrome

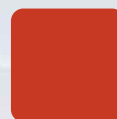

Red (Rouge) RAL 3003

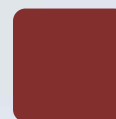

Claret RAL 3005

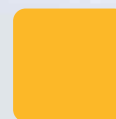

Golden Yellow RAL 1004

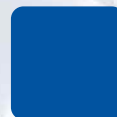

Cobalt Blue RAL 5002



Midnight Blue RAL 5003

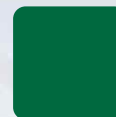

Green (Viridian) RAL 6016

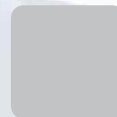

Dove Grey RAL 7036

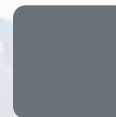

Flint Grey RAL 7043



Brown (Sienna) RAL 8017

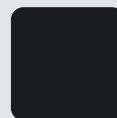

Black (Ebony) RAL 9017



Diamond White RAL 9016

Due to the limitations of the printing process we suggest that your final choice of finish is checked against the actual product.

Backcheck

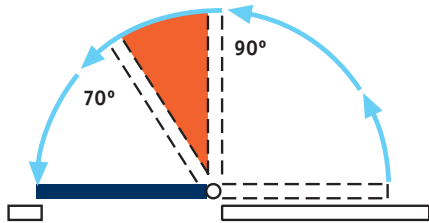

Backcheck offers resistance to opening between 70° & 90° when the door is opened with excessive force. Useful in all situations, helps prevent damage to building and door frames particularly where opening is restricted.

Note: Backcheck is not a substitute for door stops which should be fitted wherever possible.

Delayed Action

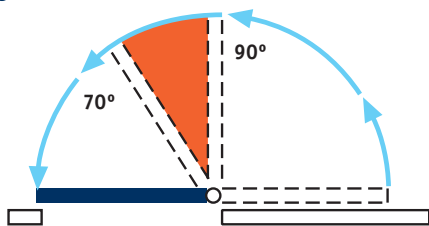

Delayed action slows down the closing speed of the door between approx 90° and 70°. The amount of delay can be adjusted and de-activated altogether. Ideally suited for applications, such as care homes, where people need a greater length of time to exit door ways.

Controlled Closing

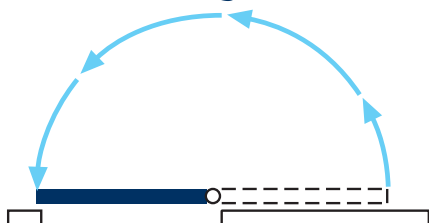

All Arrone door closers have an adjustment value which allows the closing speed to be controlled. This is effective throughout the whole closing cycle except where delayed action or latch action are activated.

Latch Action

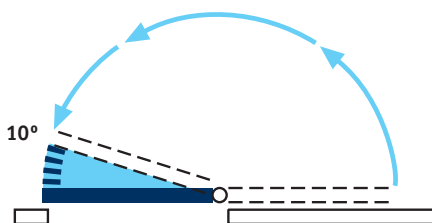

Latch action provides for the adjustment of the last 10° of closing (approx). This allows the closer to be adjusted to overcome a latch or intumescent seal.

Drop Plate

Most door closers can be supplied with a drop plate, which allows a door closer to be fitted where the top rail of the door is too narrow to allow normal fitting. The drop plate is first attached to the door and then the closer attached to the drop plate.

Stand Open/Hold Open Arms

These arms can be supplied for most door closers and when fitted will hold the door open at 90°. **STAND OPEN/HOLD OPEN ARMS MUST NOT BE USED ON FIRE RESISTING DOORS.** (see electro magnetic door controls).



DOOR CONTROLS



Overhead Door Closers

Door Closer Selection Chart

Features	AR400	AR1996	AR1000	AR2000	AR2500	AR1995	AR3002	AR1997
Universal Application Fig 1.61.66	✓	✓	✓	✓	✓	✓	✓	✓
Power Size 3	✓	✓	✓	✓	-	✓	-	-
Power Size 4	-	-	-	-	-	✓	-	-
Adj. Power 2-4	-	-	-	-	✓	-	✓	-
Adj. Power 2-6	-	-	-	-	-	-	-	✓
Fire Rating	½ hour	½ hour	½ hour	½ hour	½ hour	2 hour	1 hour	1 hour
Back Check	-	-	-	○	✓	○	✓	✓
Delayed Action	-	-	-	-	○	○	✓	✓
Slide Arms	-	-	-	-	-	○	-	-
Drop Plate	-	-	-	-	-	○	○	○
Oblong Metal Cover	-	-	✓	*	*	-	*	-
Radius Metal Cover	-	-	-	*	*	✓	*	✓
Plated Arms	-	-	-	-	-	○	○	○
Available Finishes	Silver/Gold	Silver/Gold	All	All	All	All	All	All
✓ = Standard * = Specify on ordering ○ = Optional								

DOOR CONTROLS

Please Specify the Following Information when Ordering

- Model Reference ie: AR3002
- Power Size
- Unit Function ie: Backcheck, Delayed Action
- Required Optional Features ie: Slide Arm, Hold Open Arms
- Oblong or Radius cover where applicable
- Finish

1995 Series Door Closer

The 1995 Series Door Closer Range combines the elegance of a radius metal cover with a proven reliable unit. The cover is specifically designed to complement the many ranges of round bar door furniture available in today's market place.

AR1995

Door closer (sizes 3 or 4)

Standard Features:

- British made by an ISO9000 company to exacting engineering standards
- Extruded aluminium body
- Cam and roller mechanism
- Universal application
- Fixed arm
- Adjustable latch action
- Adjustable closing speed
- Full metal radius cover

Options:

- Backcheck
- Adjustable arm
- Slide arm
- Plated arms
- Delayed action
- Drop plate (specify application)
- Stand open arms

Applications:

- Commercial or industrial applications

Fire Rating:

- Certifire approved for use on 30 minutes, 1 hour and 2 hour fire doors

Standards:

- AR1995 has been successfully type tested for conformity to all the requirements of BS EN1154. Test reports and/or certificates are available upon request

Finish:

- Silver and gold
- Polished brass
- Polished and satin stainless steel/chrome
- RAL colours

Guarantee:

The mechanism is guaranteed for 10 years against all faults in manufacture or material in the UK, Isle of Man and Channel Islands. This warranty is subject to the appropriate size and model of door closer being used, fixed, adjusted and maintained in accordance with the manufacturers recommendations.

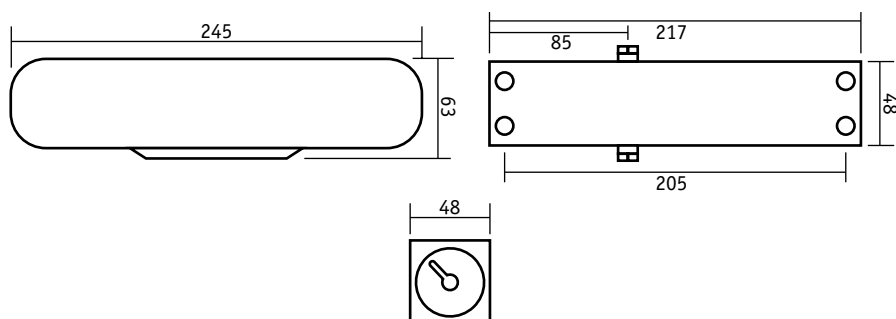

Overhead Door Closers

3002 Series Door Closer

The 3002 Series Door Closer now features a choice of either a radius or oblong metal cover. Multi-functional in operation, the unit offers variable power size 2-4 with built in backcheck and delayed action as standard.

AR3002

Door closer power adjustable (sizes 2 - 4) c/w backcheck & delayed action

Standard Features:

- Rack and pinion mechanism
- Diecast body
- Adjustable power 2 - 4 in accordance with BS EN1154
- Universal application
- Adjustable arm
- Backcheck
- Delayed action
- Adjustable closing speed
- Adjustable latch action
- Full metal cover - please specify oblong or radius

Options:

- Plated arm
- Stand open arms
- Drop plate
- Oblong or radius metal cover

Applications:

- Commercial or industrial applications

Fire Rating:

- Fire tested in accordance with BS476 part 22 1987 (1 hour)

Finish:

- Silver and gold
- Polished brass
- Polished and satin stainless steel/chrome
- RAL colours

Guarantee:

The mechanism is guaranteed for 10 years against all faults in manufacture or material in the UK, Isle of Man and Channel Islands. This warranty is subject to the appropriate size and model of door closer being used, fixed, adjusted and maintained in accordance with the manufacturers recommendations.

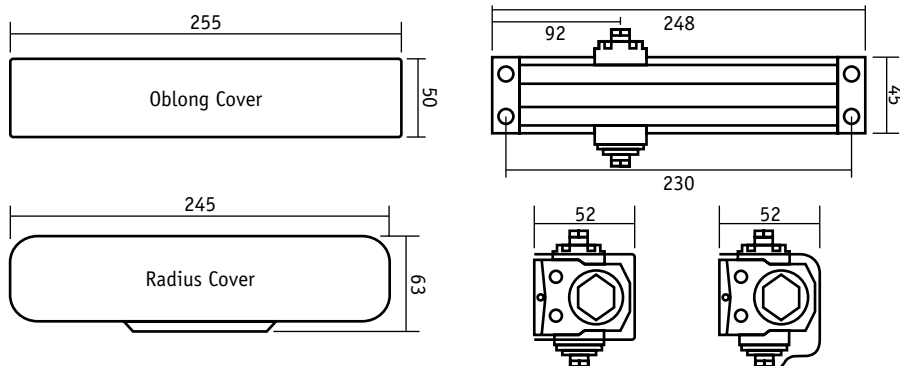

DOOR CONTROLS

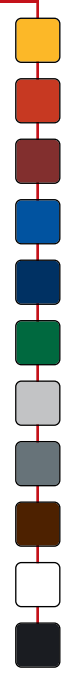
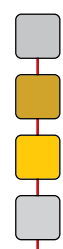

1997 Series Door Closer

This rugged heavy duty unit offers multi-functional operation featuring variable power size 2-6 with built in backcheck and delayed action as standard, coupled with the elegance of our radius metal cover. meeting the rigorous demands of todays market.

AR1997

Door closer power adjustable c/w backcheck & delayed action (sizes 2 - 6)

Standard Features:

- Rack and pinion mechanism
- Diecast body
- Adjustable power 2 - 6 in accordance with BS EN1154
- Universal application
- Adjustable arm
- Adjustable latch action
- Adjustable closing speed
- Full metal radius cover
- Backcheck
- Delayed action

Options:

- Plated arm
- Stand open arms
- Drop plate

Applications:

- Commercial or industrial applications

Fire Rating:

- Fire tested in accordance with BS476 part 22 1987 (1 hour)

Finish:

- Silver and gold
- Polished brass
- Polished and satin stainless steel/chrome
- RAL colours

Guarantee:

The mechanism is guaranteed for 10 years against all faults in manufacture or material in the UK, Isle of Man and Channel Islands. This warranty is subject to the appropriate size and model of door closer being used, fixed, adjusted and maintained in accordance with the manufacturers recommendations.

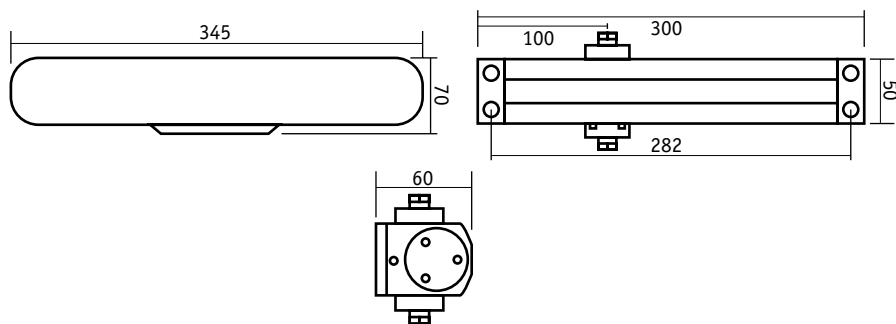

Overhead Door Closers

2000 Series Door Closer

Featuring a surface mounted rack and pinion door closer unit suitable for use in light commercial applications where modern styling is required to combine with round bar door furniture and other suites available in today's market place. Available with either a radius or conventional oblong metal cover.

AR2000

Door closer c/w metal cover (size 3)

Standard Features:

- Rack and pinion mechanism
- Size 3 in accordance with BS EN1154
- Universal application
- Adjustable black arm
- Adjustable latch action
- Adjustable closing speed
- Full metal cover - please specify oblong or radius

Options:

- Backcheck
- Stand open arms
- Oblong or radius metal cover

Applications:

- Light commercial applications

Fire Rating:

- Fire tested in accordance with BS476 part 22 1987 (30 mins)

Standards:

- Conforms to ANSI and UL standards in USA

Finish:

- Silver and gold
- Polished brass
- Polished and satin stainless steel/chrome
- RAL colours

Guarantee:

The mechanism is guaranteed for 10 years against all faults in manufacture or material in the UK, Isle of Man and Channel Islands. This warranty is subject to the appropriate size and model of door closer being used, fixed, adjusted and maintained in accordance with the manufacturers recommendations.

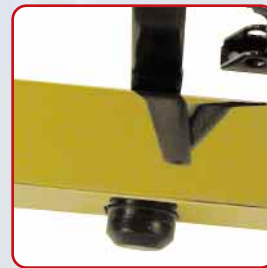
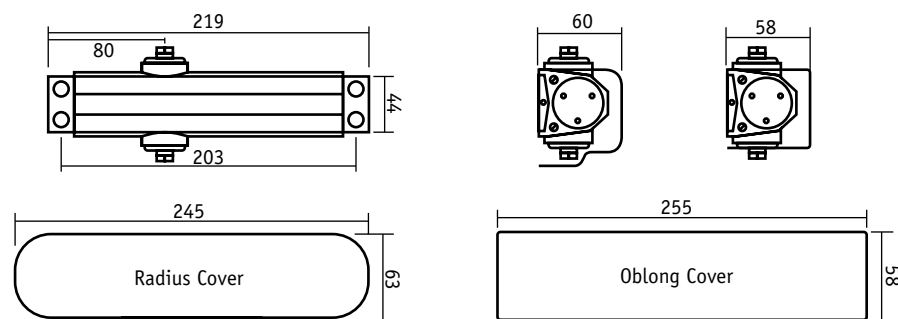

2500 Series Door Closer

The 2500 variable power unit is ideally suited for use in all types of commercial applications. Available with either a radius or conventional oblong metal cover.

AR2500 Door closer power adjustable (sizes 2 - 4) c/w backcheck

Standard Features:

- Adjustable power size 2 - 4 in accordance with BS EN1154
- Backcheck
- Universal application
- Adjustable black arm
- Adjustable latch action
- Adjustable closing speed
- Full metal cover - please specify oblong or radius
- Captive adjustable value

Options:

- Delayed action
- Stand open arms
- Oblong or radius metal cover

Applications:

- Commercial applications

Fire Rating:

- Fire tested in accordance with BS476 part 22 1987 (30 mins)

Standards:

- AR2500 has been successfully type tested for conformity to all of the requirements of BS EN1154. Test reports and/or certificates are available upon request

Finish:

- Silver and gold
- Polished brass
- Polished and satin stainless steel/chrome
- RAL colours

Guarantee:

The mechanism is guaranteed for 12 years against all faults in manufacture or material in the UK, Isle of Man and Channel Islands. This warranty is subject to the appropriate size and model of door closer being used, fixed, adjusted and maintained in accordance with the manufacturers recommendations.

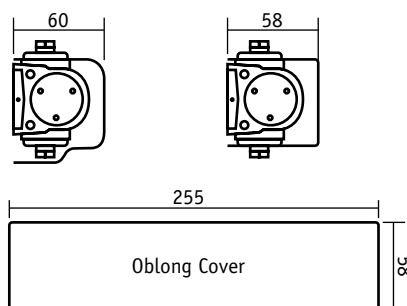
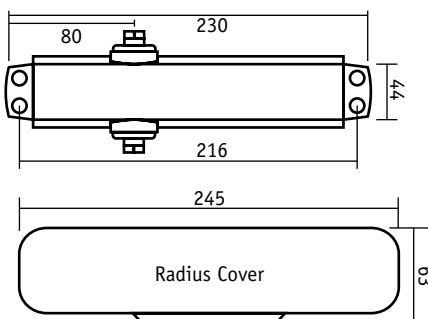

DOOR CONTROLS



Overhead Door Closers

1000 Series Door Closer

A contract door closer suitable for light duty use. The addition of an oblong metal cover enables you to offer versatility at a competitive price.

AR1000

Door closer c/w metal cover (size 3)

Standard Features:

- High performance contract door closer with the added versatility of a metal cover
- Diecast body
- Size 3 in accordance with BS EN1154
- Universal application
- Adjustable black arm
- Adjustable latch action
- Adjustable closing speed

Applications:

- Light duty commercial applications

Fire Rating:

- Fire tested in accordance with BS476 part 22 1987 (30 mins)

Finish:

- Silver and gold
- Polished brass
- Polished and satin stainless steel/chrome
- RAL colours

Guarantee:

The mechanism is guaranteed for 10 years against all faults in manufacture or material in the UK, Isle of Man and Channel Islands. This warranty is subject to the appropriate size and model of door closer being used, fixed, adjusted and maintained in accordance with the manufacturers recommendations.

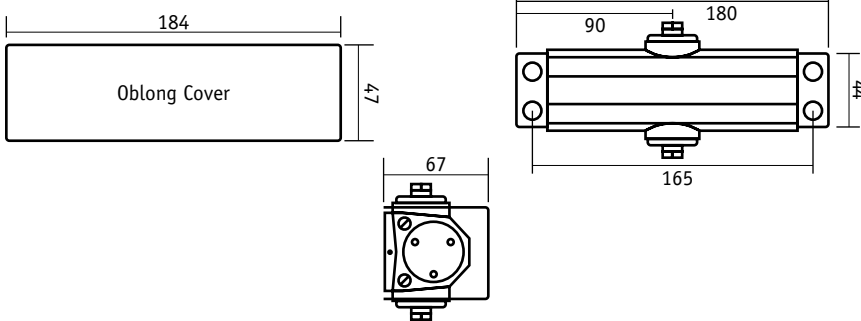

DOOR CONTROLS



400 Series Door Closer

A contract door closer offering excellent quality and suitable for light duty use at a competitive price.

AR400M

Door closer (size 3)

Standard Features:

- High performance contract door closer
- Diecast body
- Size 3 in accordance with BS EN1154
- Universal application
- Adjustable matching arm
- Adjustable latch action
- Adjustable closing speed

Applications:

- Light duty commercial applications

Fire Rating:

- Fire tested in accordance with BS476 part 22 1987 (30 mins)

Finish:

- Silver, gold

Guarantee:

The mechanism is guaranteed for 10 years against all faults in manufacture or material in the UK, Isle of Man and Channel Islands. This warranty is subject to the appropriate size and model of door closer being used, fixed, adjusted and maintained in accordance with the manufacturers recommendations.

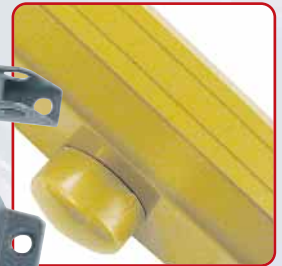
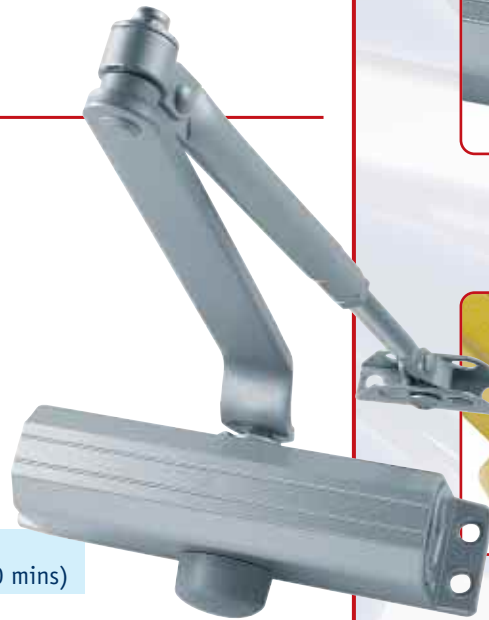
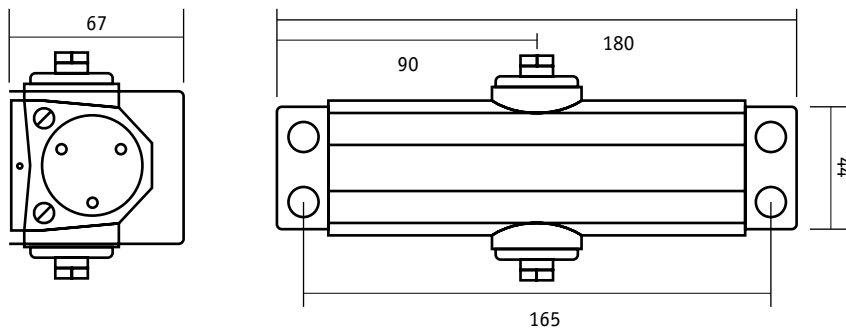

Overhead Door Closers

A high performance contract door closer suitable for light commercial applications.

AR1996

Door closer (size 3)

Standard Features:

- High performance contract door closer
- Diecast body
- Size 3 in accordance with BS EN1154
- Universal application
- Adjustable matching arm
- Adjustable latch action
- Adjustable closing speed

Applications:

- Light duty commercial applications

Fire Rating:

- Fire tested in accordance with BS476 part 22 1987 (30 mins)

Finish:

- Silver, gold

Guarantee:

The mechanism is guaranteed for 10 years against all faults in manufacture or material in the UK, Isle of Man and Channel Islands. This warranty is subject to the appropriate size and model of door closer being used, fixed, adjusted and maintained in accordance with the manufacturers recommendations.

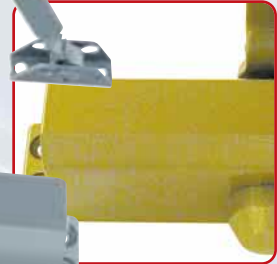
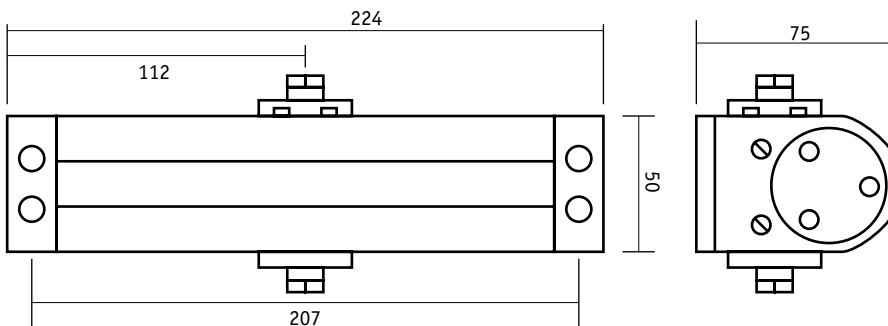

ARRONE

Floor Springs

Floor Springs

Useful Information

Performance - Adjustable Power Size 1-4

Power Size	Max Door Width	Max Door Weight
1	750mm	300kg
2	850mm	300kg
3	950mm	300kg
4	1100mm	300kg

Features

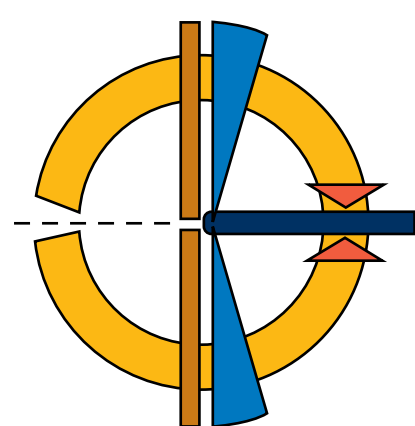

Closing Speed Adjustment Range:
Adjustment can be made throughout whole of 360° range (180° for single action).

Latch Adjustment Range:
Latching action can be adjusted for final 10° of closing.

Backcheck Range:
Backcheck can be adjusted between 70° and 90° or deactivated.

Stand Open*:
Doors will stand open at 90°. This feature must not be used on fire resisting doors (see Electro-Magnetic Door Controls).

*Optional Extra.

Gel Infill Packs

Where water resistance is required eg: swimming pools, health clubs, hospitals, external use, a Gel Infill Pack must be used to prevent corrosion.

Single Action Floor Spring

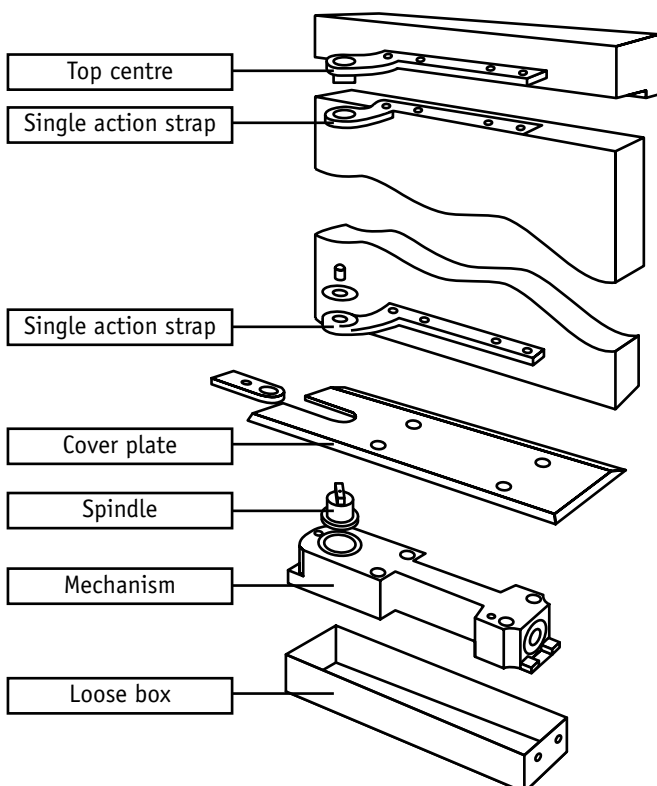

Double Action Floor Spring

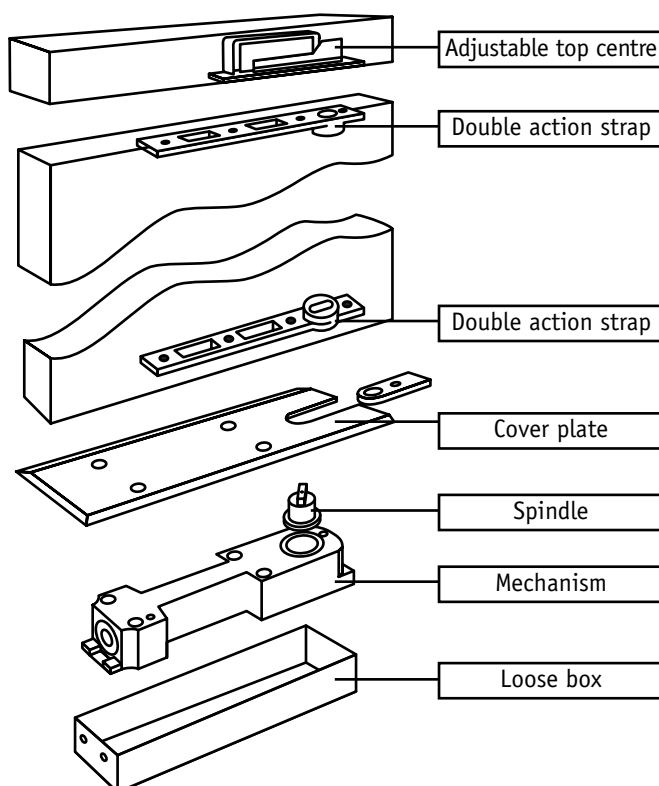

Floor Springs

An adjustable power unit which incorporates a proven cam action roller system combining smooth performance with reliability.

AR800

Floor spring (size 1-4 adjustable)

Standard Features:

- Cast iron body giving strength and durability
- Power size 1-4 adjustable
- Backcheck
- Double cam action provides perfect centering on double action doors for life
- Steel loose box with adjustable fittings (307mm x 78mm x 50mm deep)
- Temperature stabilised fluid, together with thermo constant valve to overcome temperature variance
- Suitable for timber/metal doors

Options:

- Stand open at 90° (not to be used on fire resisting doors)
- Delayed action (special order only)
- Gel infill packs for water resistance

Applications:

- Heavy duty commercial application

Fire Rating:

- Certifire approved for use on 30 minutes, 1 hour and 2 hour fire doors

Finish:

- Polished brass
- Polished stainless steel
- Satin stainless steel

Guarantee:

The mechanism is guaranteed for 5 years against all faults in manufacture or material in the UK, Isle of Man and Channel Islands. This warranty is subject to the appropriate size and model of door closer being used, fixed, adjusted and maintained in accordance with the manufacturers recommendations.

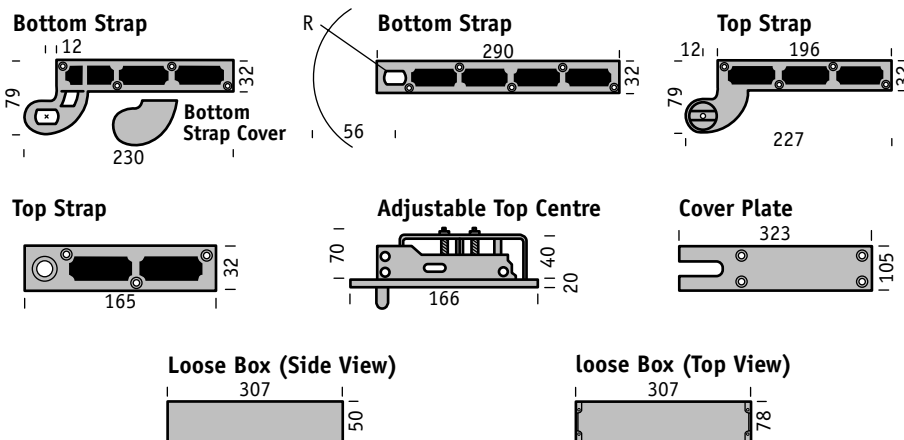

Floor Springs

Floor Springs

AR800SA	Single action floor spring complete 1x mechanism & box c/w backcheck, 1x single action accessory pack, 1x cover plate
AR800DA	Double action floor spring complete 1x mechanism & box c/w backcheck, 1x double action accessory pack, 1x cover plate
AR800SA/SO	Single action floor spring complete, stand open 1x mechanism & box c/w backcheck & stand open, 1x single action accessory pack, 1x cover plate
AR800DA/SO	Double action floor spring complete, stand open 1x mechanism & box c/w backcheck & stand open, 1x double action accessory pack, 1x cover plate

Please Note: Stand Open Floor Springs Should not be used on Fire Doors

Accessories

ARSAAP	Single action accessory pack 1x single action top centre, 1x single action bottom strap
ARDAAP	Double action accessory pack 1x double action adjustable top centre, 1x double action bottom strap

Cover Plates

AR801B	Cover plate brass (323mm x 105mm)
AR801SS	Cover plate satin stainless steel (323mm x 105mm)
AR801PS	Cover plate polished stainless steel (323mm x 105mm)

Gel Infill Packs

Recommended for any application where water resistance is required. ie:

- Swimming Pools
- Health Clubs/Sports Centres
- Hospitals
- External use

ARGEL	Gel infill pack
--------------	-----------------



ARRONE

Electro Magnetic Door Controls

Electro Magnetic Door Closer

Electro Magnetic Door Closers

Brought to you in partnership with Jebron, one of the UK's leading manufacturers of door controls. The ARRONE Range of Electro Magnetic units complements our traditional door closer range.

Electro Magnetic door controls offer the specifier and end user a solution to the difficult problem of balancing accessibility with fire containment. As such this range is ideal for use in hospitals and residential homes.

Designed for situations where it is desirable to have a fire resisting door either hold open or free swinging under normal conditions, whilst maintaining the integrity of the fire door in a fire situation.

When used in either swing free or hold open application the door will automatically close upon activation of the fire alarm or power failure. Also included is a test switch for regular testing of the unit.

Performance - in accordance with BS EN1155

Power Size	Max Door Width	Max Door Weight
3	950mm	60kg
4	1100mm	80kg

Power Supply

24v DC. Transformer rectifiers are available to operate up to 50 units.

Installation

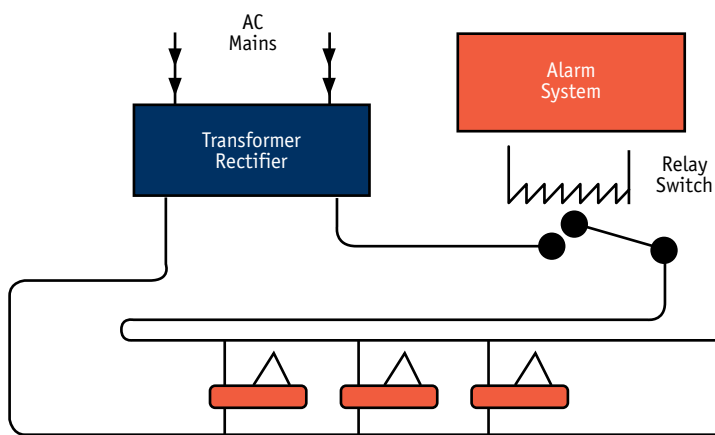

External Use

Electro Magnetic door closers **MUST NOT** be used in external or wet area applications.

Door Closers Finishes and Colours



Silver



Gold



Polished Brass



Polished & Satin Stainless Steel/Chrome



Red (Rouge)
RAL 3003



Claret
RAL 3005

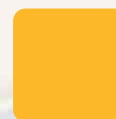

Golden Yellow
RAL 1004



Cobalt Blue
RAL 5002

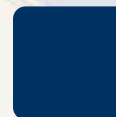

Midnight Blue
RAL 5003

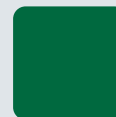

Green (Viridian)
RAL 6016

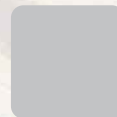

Dove Grey
RAL 7036

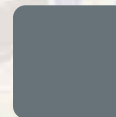

Flint Grey
RAL 7043



Brown (Sienna)
RAL 8017

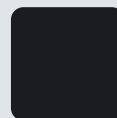

Black (Ebony)
RAL 9017



Diamond White
RAL 9016

Due to the limitations of the printing process we suggest that your final choice of finish is checked against the actual product.

Electro Magnetic Door Closers

AR1998/9 Electro magnetic door closer (selectable size 3/4)

Standard Features:

- Selectable hold open - swing free
- Power size 3-4 selectable in accordance with BS EN1155
- Universal application fig 1.66
- Cam and roller mechanism
- Adjustable latch action
- Adjustable closing speed
- Full metal radius cover
- Flexible link and terminal box
- Switch for testing purposes

Standards:

This product has been successfully type-tested for conformity to all the requirements of BS EN1155. Test reports and/or certificates are available upon request

Finish:

- Silver and gold
- Polished brass
- Polished and satin stainless steel
- RAL colours

Guarantee:

The mechanism is guaranteed for 1 year against all faults in manufacture or material in the UK, Isle of Man and Channel Islands. This warranty is subject to the appropriate size and model of door closer being used, fixed, adjusted and maintained in accordance with the manufacturers recommendations.

Accessories

AR-TR10	Transformer rectifier unit inc fuse (1-10 closers)
AR-TR30	Transformer rectifier unit inc fuse (1-30 closers)
AR-TR50	Transformer rectifier unit inc fuse (1-50 closers)



DOOR CONTROLS



Electro Magnetic Floor Springs

Electro Magnetic Floor Springs

Complementing our floor spring range this electro magnetic unit features hold open and is ideal for use on heavy duty fire resisting doors.

Often used in conjunction with a detector/alarm system, holding open at any angle between 80° and 170° when the device is energised.

When used in this hold open application the door will automatically close upon activation of the fire alarm or power failure.

Ideal for use in hospitals, nursing homes and any building frequented by elderly people where free access is required.

Performance

Power size 4 suitable for doors up to 1100mm wide/300kg weight.

Power Supply

24v DC. Transformer rectifiers are available to operate up to 50 units.

Installation

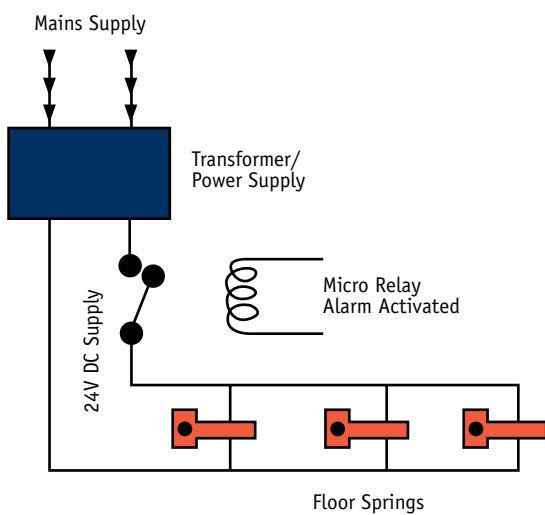
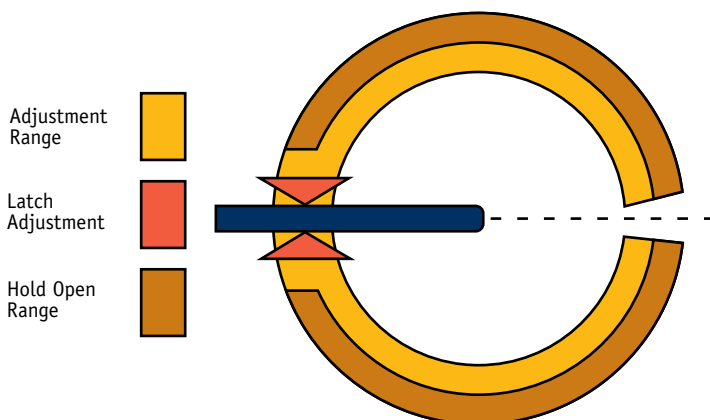

External Use

Electro Magnetic floor springs **MUST NOT** be used in external or wet area applications.



Electro Magnetic Floor Springs

AR800 EMS0

Electro magnetic floor spring

Standard Features:

- Cast iron body giving strength and durability
- Power size 4
- Electro magnetic hold open
- 24v DC power supply
- Double cam action providing perfect centering on double action doors for life
- Steel loose box with adjustable fittings
- Temperature stabilised fluid, together with thermo constant valve to overcome temperature variance
- Switch for timber/metal doors

Application:

Heavy duty commercial application where 'hold open' is required

Finishes:

- Polished brass
- Polished and satin stainless steel

Guarantee:

The mechanism is guaranteed for 5 years against all faults in manufacture or material in the UK, Isle of Man and Channel Islands. This warranty is subject to the appropriate size and model of floor spring being used, fixed, adjusted and maintained in accordance with the manufacturers recommendations.

Accessories

ARSAAP	Single action accessory pack 1x single action top centre, 1x single action bottom strap
ARDAAP	Double action accessory pack 1x double action adjustable top centre, 1x double action bottom strap
AR-TR10	Transformer rectifier unit inc fuse (1-10 closers)
AR-TR30	Transformer rectifier unit inc fuse (1-30 closers)
AR-TR50	Transformer rectifier unit inc fuse (1-50 closers)



Electro Magnetic Door Holders

Electro Magnetic Door Holders

Electro magnetic door holders are designed to hold the door in the OPEN position, allowing it to close when either the FIRE ALARM is activated or the POWER FAILS. Recommended for use in conjunction with overhead door closer or floor springs.

AR-8087 Surface mounted door holder white

AR-8057 Floor mounting bracket white

AR-8159-CH Flush mounted door holder polished chrome

AR-8159-PB Flush mounted door holder polished brass

AR-8259-CH Flush mounted door holder with switch polished chrome

AR-8259-PB Flush mounted door holder with switch polished brass

Accessories

AR-TR10 Transformer rectifier unit inc fuse (1-10 closers)

AR-TR30 Transformer rectifier unit inc fuse (1-30 closers)

AR-TR50 Transformer rectifier unit inc fuse (1-50 closers)

Note: Not to be used in external or wet area applications.



AR-8159-PB



AR-8259-PB



ARRONE

Emergency Exit Hardware

Emergency Exit Hardware

Two ranges of Emergency Exit Hardware products continue to satisfy most of the applications required in today's demanding market place, whilst at the same time being successfully tested to the latest European standards BS EN1125 & BS EN179. It should however be noted that the emphasis for products covered under the new standards is on **safety** rather than **security**.

Arrone Emergency Exit Hardware offers quality products at competitive prices with innovative design features supported by solid engineering principles.

Manufactured in France, the elegantly designed JPM range offers a modern solution to emergency egress in prestigious architectural projects.

A Guide to New European Standards

BS EN1125 1997 - Panic Exit Devices

Experience relating to escape from buildings and general safety have made it desirable that doors at exits in public buildings, places of entertainment, shops etc should be fitted with panic devices operated by a horizontal bar. The emphasis for products covered by this standard is ON SAFE EXIT RATHER THAN SECURITY.

BS EN179 1998 - Emergency Exit Devices

This standard covers devices to be used in emergency situations where people are familiar with the emergency exit and its hardware and therefore a panic situation is most unlikely to develop. Lever handle operated escape mortice locks or push pads may therefore be used. THESE DEVICES MUST NOT BE USED IN OPEN PUBLIC AREAS.

Double Panic Bolts

The traditional Double panic bolt is NO LONGER PERMISSIBLE under the requirements of the new standard. Specifications MUST PROVIDE a single panic bolt and panic latch for pairs of doors with REBATED meeting stiles. When panic latches are used in this situation they must be fitted to the first opening leaf of the door set. Pairs of doors with plain meeting stiles should be fitted with two single panic bolts.

Standards Applicable to Arrone Emergency Exit Hardware

AR880 Single Panic Bolt, AR882 Reversible Panic Latch and AR888 Combination Unit for Rebated Doors:

Successfully tested to BS EN1125: 1997 clause 6

AR883 Push Pad and AR 884 Push Pad Panic Bolt:
Successfully tested to BS EN179: 1998 clause 6

AR889 Combination Unit for Rebated Doors:

Successfully tested to BS EN1125: 1997 clause 6 and BS EN179: 1998 clause 6

Finishes

Please note Brass and Stainless Steel plated finishes are not suitable for external use.

Guarantee

The mechanism is guaranteed for 2 years against all faults in manufacture or material in the UK, Isle of Man and Channel Islands. This warranty is subject to the emergency exit hardware being used, fixed, adjusted and maintained in accordance with the manufacturers recommendations.

Emergency Exit Hardware Finishes and Colours



Silver



Gold

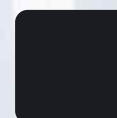

Black



Polished Brass



Polished & Satin Stainless Steel/Chrome

RAL Colours to Special Order



Red (Rouge)
RAL 3003

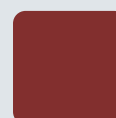

Claret
RAL 3005

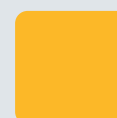

Golden Yellow
RAL 1004

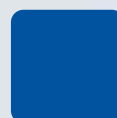

Cobalt Blue
RAL 5002

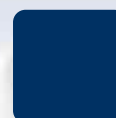

Midnight Blue
RAL 5003



Green (Viridian)
RAL 6016

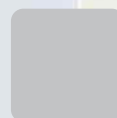

Dove Grey
RAL 7036



Flint Grey
RAL 7043



Brown (Sienna)
RAL 8017



Diamond White
RAL 9016

Due to the limitations of the printing process we suggest that your final choice of finish is checked against the actual product.

AR880

Single panic bolt

Standard Features:

- Automatic top trip
- Two point locking
- Diecast control boxes
- Follower on main box for use with AR885 locking attachment
- Anti thrust device preventing leverage of top and bottom shoots
- Oval steel rods
- Self handing
- Suitable for door sizes up to 2440mm x 1220mm (extended top shoots available)
- Pullman latch kit available
- AR880 has been successfully tested for conformity to all the requirements of BS EN1125: 1997 clause 6. Test reports and/or certificates are available upon request

Applications:

- For single or double doors with plain meeting stiles

Finish:

- Silver, gold and black
- Polished brass, polished and satin stainless steel/chrome
- RAL colours

AR890

Pullman latch kit

Standard Features:

- Two point locking
- Top and bottom latch kits
- Easily fits to standard Arrone panic bolt
- Anti thrust device preventing leverage of top and bottom latches
- Adjustable fixing position
- Offers smooth action and prevents jamming of mechanism

Applications:

- For use in conjunction with AR880 single panic bolt and AR884 push pad panic bolt

Finish:

- Silver, gold and black
- Polished brass, polished and satin stainless steel/chrome
- RAL colours

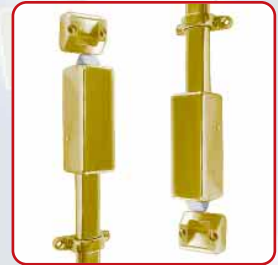

Emergency Exit Hardware

AR882

Reversible panic latch

Standard Features:

- Single point locking
- Diecast control boxes
- Follower on main box for use with AR885 locking attachment
- Oval steel rods
- Reversible
- Suitable for door widths up to 1220mm
- AR882 has been successfully tested for conformity to all the requirements of BS EN1125: 1997 clause 6. Test reports and/or certificates are available upon request

Applications:

- For single doors or first opening leaf of double doors with rebated meeting stiles

Finish:

- Silver, gold and black
- Polished brass, polished and satin stainless steel/chrome
- RAL colours

AR883

Reversible push pad

Standard Features:

- Single point locking
- Diecast control boxes
- Follower on main box for use with AR885 locking attachment
- Reversible
- Suitable for any door width
- AR883 has been successfully tested for conformity to all the requirements of BS EN179: 1998 clause 6. Test reports and/or certificates are available upon request

Applications:

- For single doors or first opening leaf of double doors with rebated meeting stiles

Finish:

- Silver, gold and black
- Polished brass, polished and satin stainless steel/chrome
- RAL colours

Please Note:

AR883 reversible push pad should not be used in OPEN PUBLIC AREAS as per BS EN179.



AR884

Push pad single panic bolt

Standard Features:

- Automatic top trip
- Two point locking
- Diecast control boxes
- Follower on main box for use with AR885 locking attachment
- Anti thrust device preventing leverage of top and bottom shoots
- Oval steel rods
- Self handing
- Suitable for door sizes up to 2440mm (extended top shoots available)
- Pullman latch kit available
- AR884 has been successfully tested for conformity to all the requirements of BS EN179: 1997 clause 6. Test reports and/or certificates are available upon request

Applications:

- For single doors or first opening leaf of double doors with rebated meeting stiles

Finish:

- Silver, gold and black
- Polished brass, polished and satin stainless steel/chrome
- RAL colours

Please Note:

AR884 push pad panic bolt should not be used in OPEN PUBLIC AREAS as per BS EN179.

AR890

Pullman latch kit

Standard Features:

- Two point locking
- Top and bottom latch kits
- Easily fits to standard Arrone panic bolt
- Anti thrust device preventing leverage of top and bottom latches
- Adjustable fixing position
- Offers smooth action and prevents jamming of mechanism

Applications:

- For use in conjunction with AR880 single panic bolt and AR884 push pad panic bolt

Finish:

- Silver, gold and black
- Polished brass, polished and satin stainless steel/chrome
- RAL colours

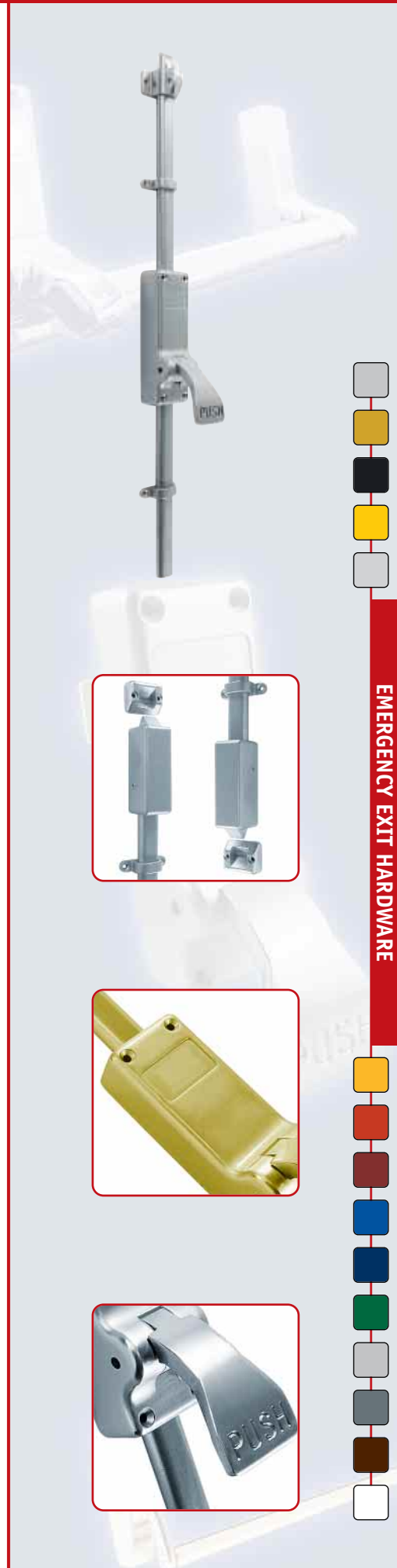

Emergency Exit Hardware

AR888

Combination unit for double rebated doors

Comprises:

- AR880 single panic bolt
- AR882 reversible panic latch
- AR887 double door strike
- AR888 has been successfully tested for conformity to all the requirements of BS EN1125: 1997 clause 6. Test reports and/or certificates are available upon request

Applications:

- For double rebated doors in accordance with BS EN1125

Finish:

- Silver, gold and black
- Polished brass, polished and satin stainless steel/chrome
- RAL colours

AR889

Combination unit for double rebated doors

Comprises:

- AR880 single panic bolt
- AR883 reversible push pad
- AR887 double door strike
- AR889 has been successfully tested for conformity to all the requirements of BS EN1125: 1997 clause 6 and BS EN179: 1998 clause 6. Test reports and/or certificates are available upon request

Applications:

- For double rebated doors in accordance with BS EN1125 & BS EN179

Finish:

- Silver, gold and black
- Polished brass, polished and satin stainless steel/chrome
- RAL colours

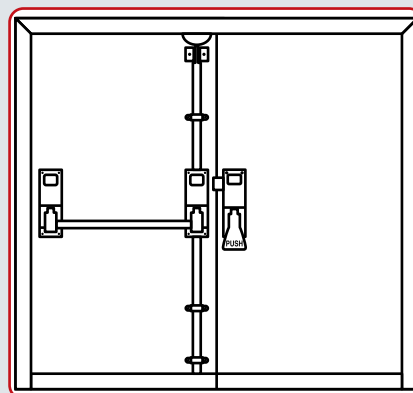
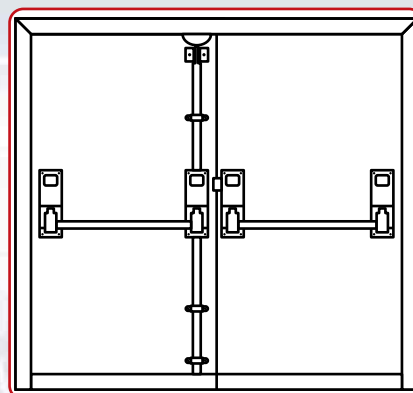

AR885 External locking attachments

Standard Features:

- Diecast control boxes
- Suitable for all items within range
- Available without cylinder. (Order AR886)
- Unique pad handle design

Applications:

- For use with all Arrone Emergency Exit Hardware

Finish:

- Silver, gold and black

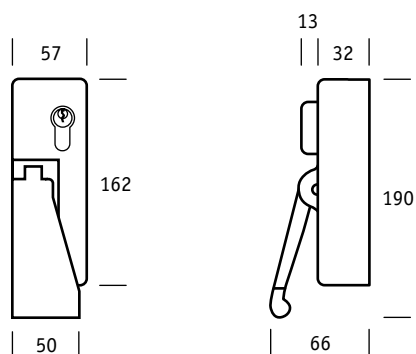

Double Panic Bolt

AR881 Double panic bolt

- Please note: Double panic bolts are a non conforming product. See Emergency Exit Hardware information page.

Accessories

AR887	Double door strike
ARETS	2 metre extended top shoot
AR3MET	3 metre extended top shoot
ARXARM	1.5 metre cross arm
ARSSG	Spare shoot guides
AR880FP	Fixing pack to suit AR880



Emergency Exit Hardware

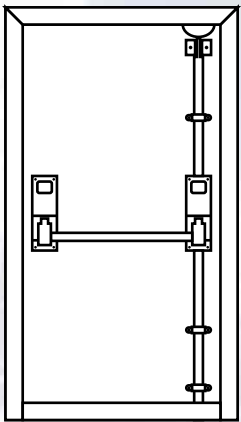

AR880

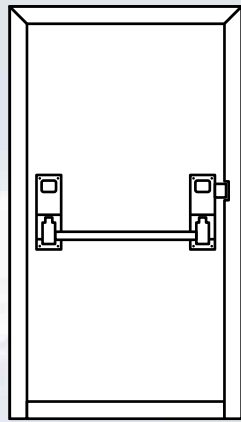

AR882

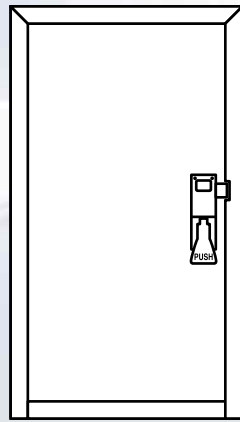

AR883

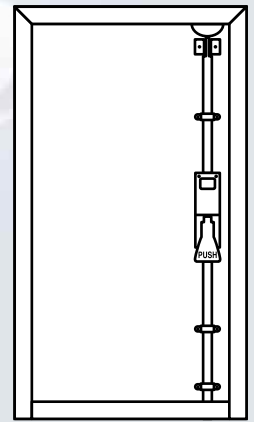

AR884

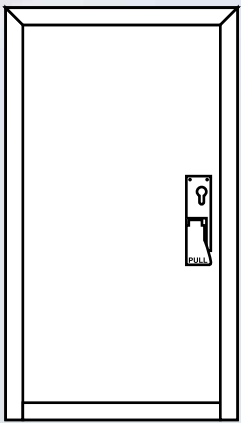

AR885

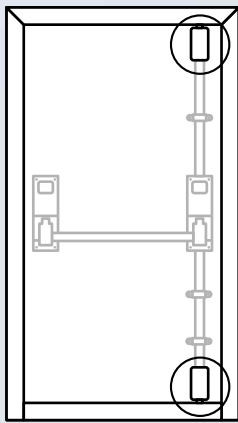

AR890

Single Panic Bolt Not Supplied

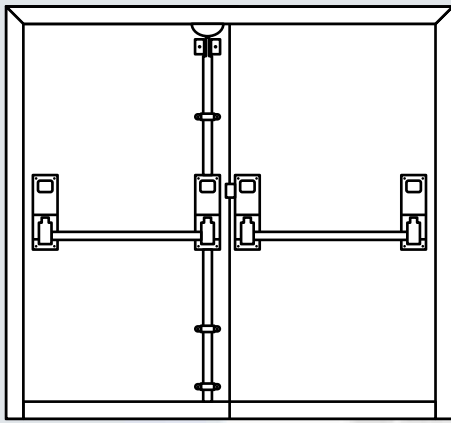

AR888

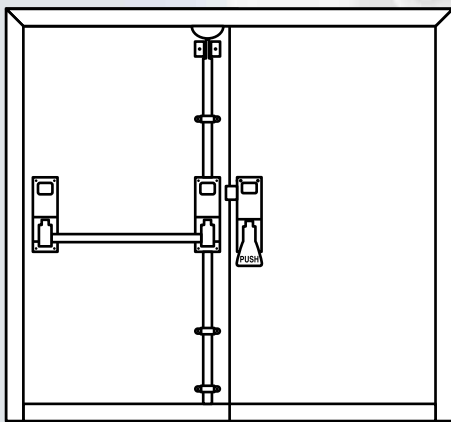

AR889

Panic Bolt & Push Pad Technical Details

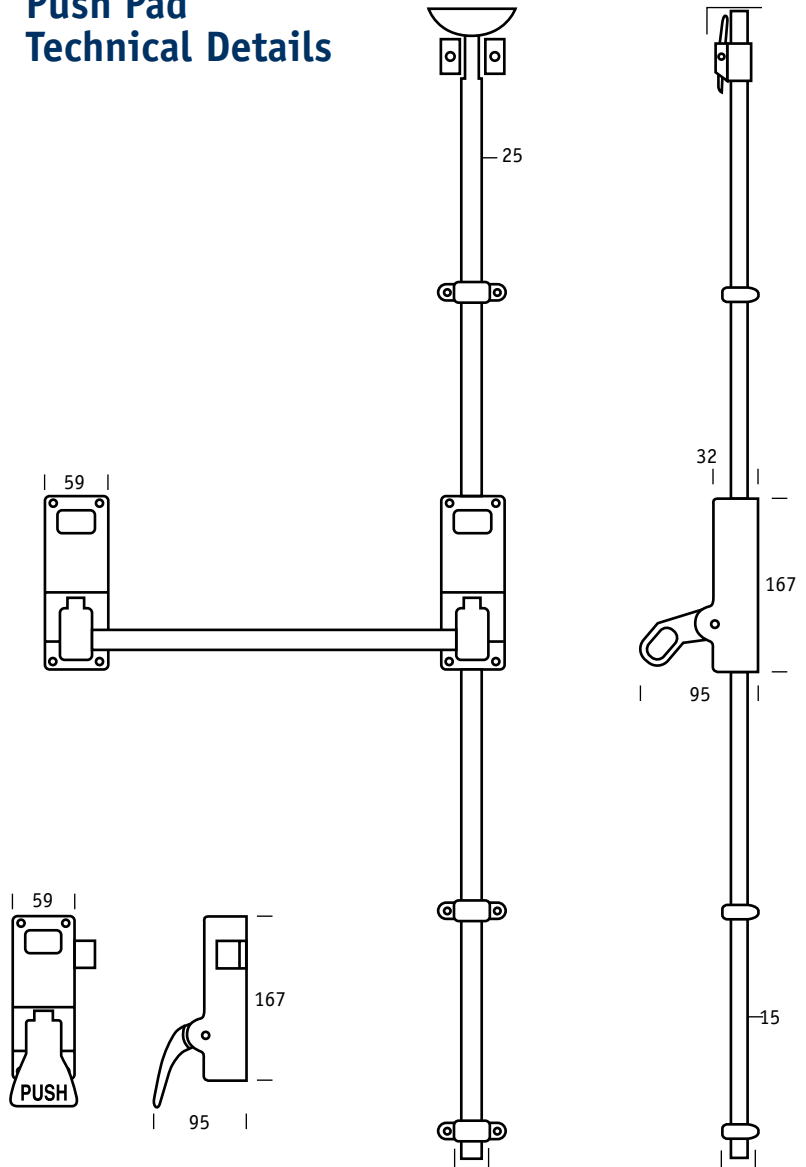

EMERGENCY EXIT HARDWARE

Exit Devices

Fire safety linked to security, whether it be from a designer or specifiers viewpoint this now demands a specialist approach in providing product to ensure the absolute safety of employer and general public alike.

JPM Panic Exit devices are not only functional and elegant in their design but meet, where applicable, exacting European Standards BS EN1125, BS EN179 plus American National Standards Institute (ANSI) A156-3 (NF Listed). Mechanical hardware is covered by a five year guarantee.

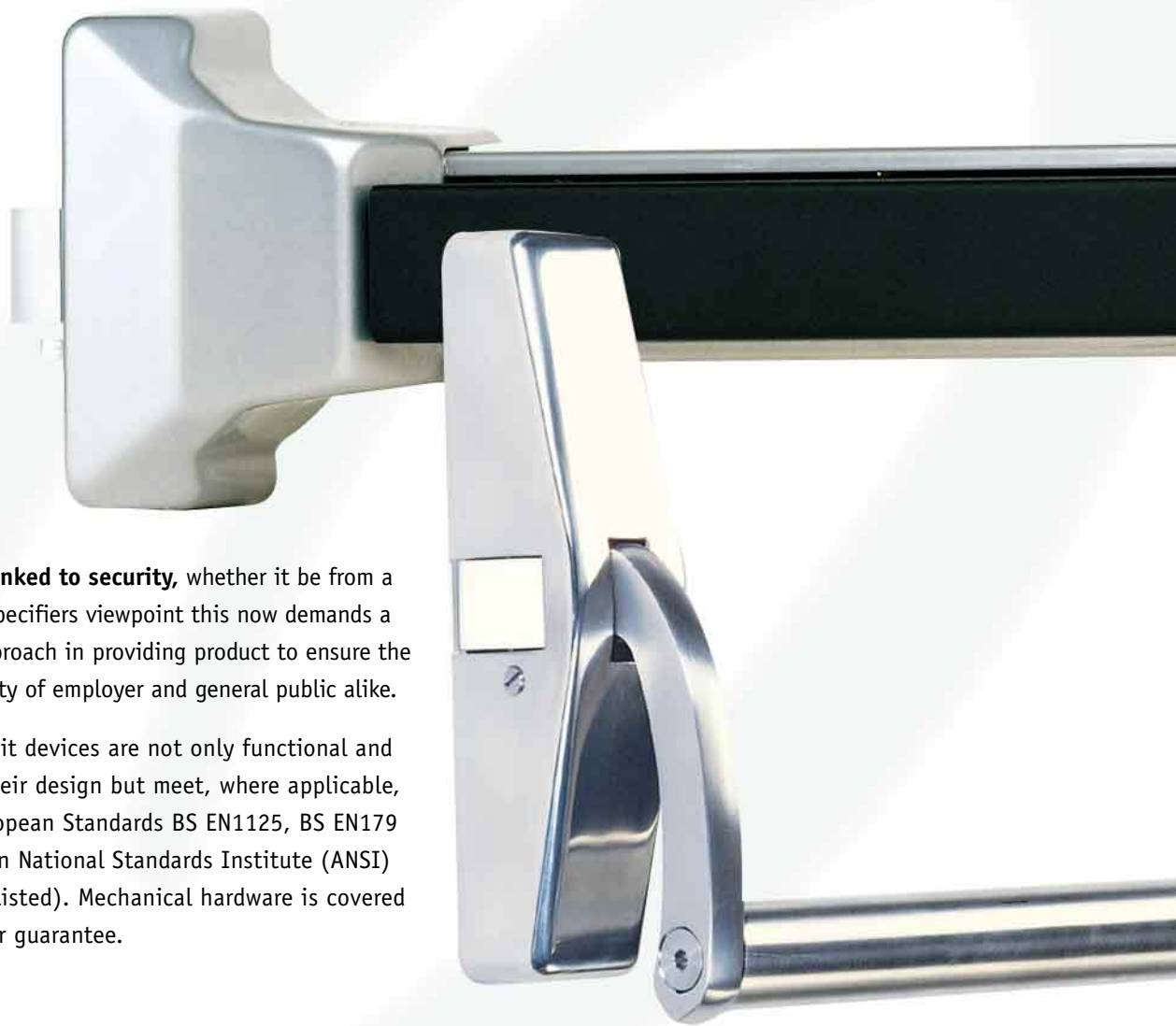

Exit Devices

Series 89 Range

Not only elegantly designed, the Series 89 is also a highly sophisticated, functional and flexible solution to emergency exit requirements, including fire doors.

The two and three point locking versions with 'Pullman' latches at top and bottom give immediate release on opening (vital in a 'panic' situation) and the door re-latches securely on closing. The 8901 single point latch is equally effective.

Brackets to suit are only 42mm wide, allowing fitting to most narrow stile doors - the push-bar itself extends full width across the door for increased safety in use.

The Series 89 is perfect for any high usage situation where its smooth operation and durable mechanics ensure long life, safety and security.

JPM8901 Single point locking panic latch

Standard features:

- Cross follower on the main case for use with outside trim (EN2000)
- Spring loaded cross bar in the hinge case
- 900mm wide field adjustable release bar
- Successfully tested to BS EN1125 1997: clause 6. Test reports and/or certificates are available upon request

Applications:

- For single door or first opening leaf on a pair of doors. Double rebated doors use 8901 together with 8902

Finish:

- Silver enamel. Other finishes, including stainless steel are available to special order

JPM8902 Two point locking panic latch top and bottom 'Pullman' latches

Standard features:

- Cross follower on the main case for use with outside trim (EN2000)
- Spring loaded cross bar in the hinge case
- 900mm wide field adjustable release bar
- 2400mm maximum door height
- Successfully tested to BS EN1125 1997: clause 6. Test reports and/or certificates are available upon request

Applications:

- Single door or pair of doors. For double rebated doors use 8902 together with an 8901

Finish:

- Silver enamel. Other finishes, including stainless steel are available to special order

JPM8903 Three point locking panic bolt top & bottom 'Pullman' latches and side latch

Standard features:

- Cross follower on the main case for use with outside trim (EN2000)
- Spring loaded cross bar in the hinge case
- 900mm wide field adjustable release bar
- 2400mm maximum door height
- Successfully tested to BS EN1125 1997: clause 6. Test reports and/or certificates are available upon request

Applications:

- For single doors

Finish:

- Silver enamel. Other finishes, including stainless steel are available to special order



Series 90 Range

Safe exit at a touch. The Series 90 Touch-Bar is a supremely efficient device allowing exit at the lightest of touches anywhere along the length of the bar.

Its stylish, modern looks make it the specifiers choice for many situations, but the Series 90 has many advantages, its low projection from the door surface enables fitting where door opening space is limited. This flat design also reduces possibility of injury in an emergency situation.

Whether specification is for single or two point 'Pullman' deadlocking latches, a high degree of security exists when the door is closed. The two point latches will remain retracted whilst the door is open.

The Series 90 embodies today's need for style and high performance in tandem.

JPM9000

Single point locking panic latch

Standard features:

- Cross followers
- Deadlocking latch
- Field adjustable touch-bar: 900mm wide
- Successfully tested to BS EN1125 1997: clause 6. Test reports and/or certificates are available upon request

Applications:

- For single door or first opening leaf on a pair of doors

Finish:

- Silver enamel with black touch-bar. Other finishes are available to special order

JPM9300

Two point locking panic latch top and bottom 'Pullman' latches

Standard features:

- Cross followers
- Field adjustable touch-bar: 900mm wide
- Maximum door height: 2400mm
- Deadlocking - anti thrust device to safeguard against manipulation of top and bottom latches (from exterior)
- Top and bottom rods and covers
- Successfully tested to BS EN1125 1997: clause 6. Test reports and/or certificates are available upon request

Applications:

- For Single door or pair of doors (non rebated)

Finish:

- Silver enamel with black touch-bar. Other finishes are available to special order



Exit Devices

JPM EN 2000 Outside Trim

The **perfect complement** to either the Series 89 or 90, the EN 2000 has the smart appearance to suit the most prestigious location - and the high security performance to match.

JPM EN 2000

External locking attachment

Advantages:

- Non-handed - reversible trim to suit either Series 89 Push-Bar or Series 90 Touch-Bar
- Vandal resistant 'shear' feature handle
- Key retaining cylinder
- Easy installation, suits any door using a single euro profile cylinder
- Cylinder can be replaced without removing panic device
- Bolt through fitting

Technical features:

- Suitable for Panic devices JPM Series 89 and 90
- Reversible lever handle
- Dimensions: 220x42x20mm
- Removable cylinder protector (half cylinder supplied separately)
- Left or right hand locking

Operation:

- Allows controlled access
- The handle is activated by a single turn of the key
- Key retaining cylinder, key can only be removed when trim is locked (to special order)
- Lever handle with 'shear' feature
- If excessive force applied (torque>15N), the handle will disengage to prevent door opening and also to protect lock mechanism

Finish:

- Standard: epoxy silver coated. Black, white, stainless steel and RAL colours available to special order

NB: This product is not compatible with ARRONE Exit Hardware.



ARRONE

Architectural Lockcases & Cylinders

Architectural Lockcases & Cylinders



High Quality - High Security

CES' production of locks and cylinders uses state of the art technology. The use of CNC-controlled machines guarantees top quality at competitive prices.

The observance of tight manufacturing tolerances, strict quality control in all production areas as well as the processing of high quality materials are a matter of course.

CES is a company renowned for its locks and cylinders the world over.

Locks & Cylinders



ARRONE

Complementing the CES range of German DIN standard locks, the ARRONE range of cylinder lock cases offer heavy sprung locks with UK backsets and centres.

The lockcases are easily reversible on site without the need to open the lockcase.

The 6 pin convenience stock suite of cylinders offers a range of cylinders ready made to a single master key where speed of delivery is important.

Locks & Cylinders



CES Architectural Mortice Lockcases

- 72mm Centres (78mm on Bathroom Lock)
- **Heavy Springing suitable for heavy unsprung furniture**
- Latchbolt withdrawn by lever or key on sashlock
- 55mm Backset
- Manufactured to DIN standard 18251 (except Bathroom Lock)
- Forend 24mm x 235mm
- Easily reversible spring bolt
- 8mm Follower

Mortice Sashlocks

CES-7734-SS	Euro profile sashlock case	SS
CES-7734-PB	Euro profile sashlock case	PB

Mortice Deadlocks

CES-7730-02-SS	Euro profile deadlock case	SS
CES-7730-02-PB	Euro profile deadlock case	PB

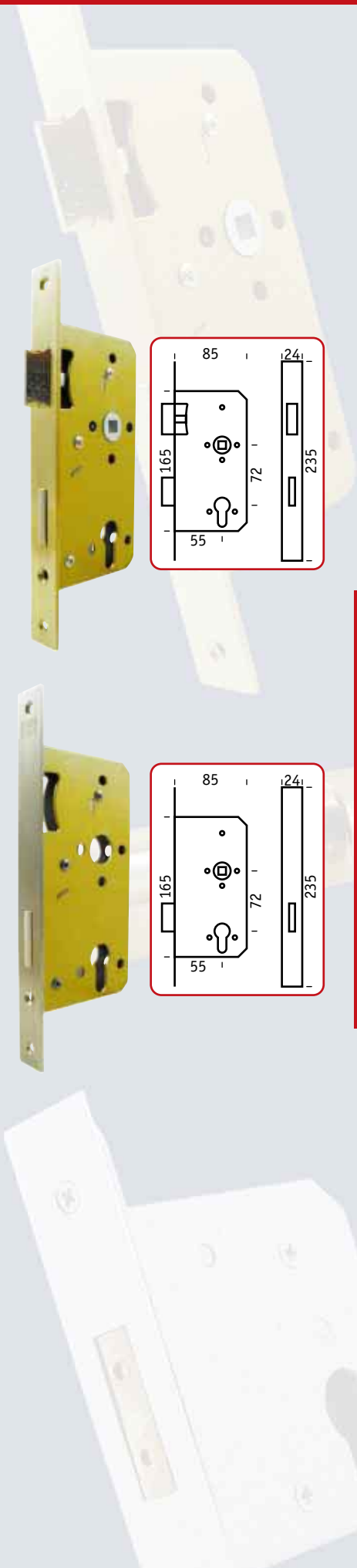

Architectural Lockcases & Cylinders

CES Architectural Mortice Lockcases

- 72mm Centres (78mm on Bathroom Lock)
- **Heavy Springing suitable for heavy unsprung furniture**
- 55mm Backset
- Manufactured to DIN standard 18251 (except Bathroom Lock)
- Forend 24mm x 235mm
- Easily reversible spring bolt
- 8mm Follower

Mortice Nightlatch (Operated by Handle & Key)

- Providing entry by key and exit by thumbturn and/or half set lever handles

CES-7734-01-SS	Euro profile nightlatch case	SS
CES-7734-01-PB	Euro profile nightlatch case	PB

Mortice Latch - Lever Operated - Non Locking

CES-7700-01-SS	Euro profile latch case	SS
CES-7700-01-PB	Euro profile latch case	PB

Mortice Bathroom Lock (5mm Turn Follower)

CES-7790-SS	Euro profile bathroom lock case	SS
CES-7790-PB	Euro profile bathroom lock case	PB

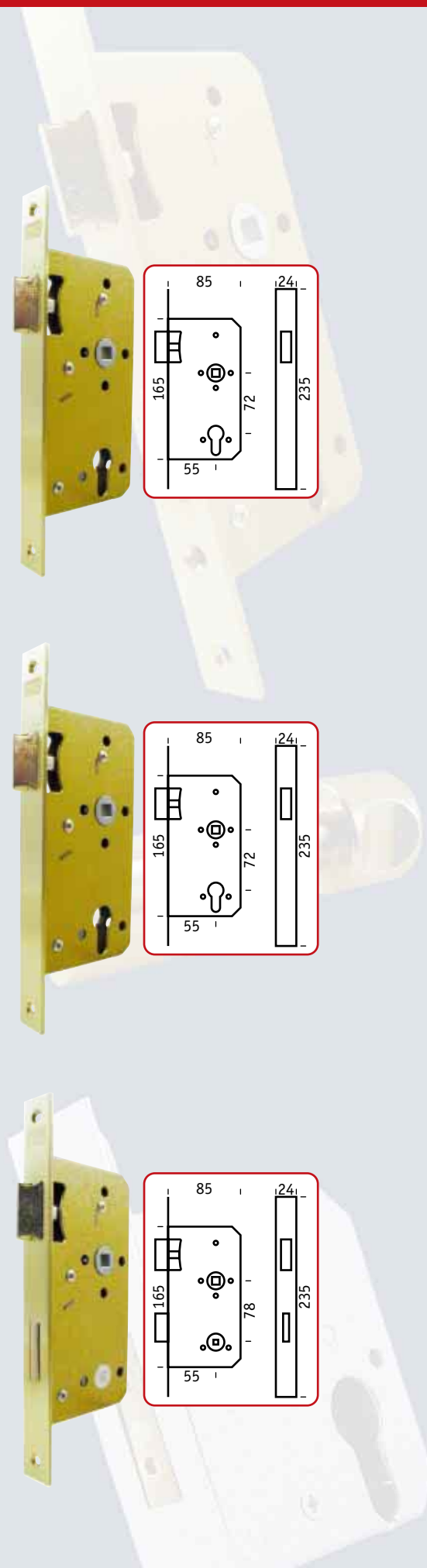

Architectural Cylinder Mortice Sashlock Cases

- Heavy duty springing to suit unsprung furniture
- Easily reversible brass latchbolt
- Hardened steel rollers in brass deadbolt
- Suitable for bolt through furniture (38mm centres)
- Box striking plate to complement forend
- 8mm follower
- Hammered silver steel case
- 10 per box complete with fixing screws

Oval Profile Mortice Sashlock Cases

AR/M-703-63-BR	63mm Oval profile mortice sashlock case	BR
AR/M-703-63-SC	63mm Oval profile mortice sashlock case	SC
AR/M-703-75-BR	76mm Oval profile mortice sashlock case	BR
AR/M-703-75-SC	76mm Oval profile mortice sashlock case	SC

Euro Profile Mortice Sashlock Cases

AR/M-704-63-BR	63mm Euro profile mortice sashlock case	BR
AR/M-704-63-SC	63mm Euro profile mortice sashlock case	SC
AR/M-704-75-BR	76mm Euro profile mortice sashlock case	BR
AR/M-704-75-SC	76mm Euro profile mortice sashlock case	SC

Rebate Sets to Suit: AR/M-703/704 Sashlocks

AR/M-729-13-BR	13mm Rebate set	BR
AR/M-729-13-SC	13mm Rebate set	SC
AR/M-729-25-BR	25mm Rebate set	BR
AR/M-729-25-SC	25mm Rebate set	SC

Cylinder Mortice Nightlatch Cases

- Heavy duty springing to suit unsprung furniture
- Easily reversible brass latchbolt
- Stainless Steel anti thrust snib
- 8mm brass follower
- Striking plate to match forend

AR/BS-2510-EP-BR	76mm Euro profile mortice nightlatch case	BR
AR/BS-2510-EP-SS	76mm Euro profile mortice nightlatch case	SS
AR/BS-2510-OP-BR	76mm Oval profile mortice nightlatch case	BR
AR/BS-2510-OP-SS	76mm Oval profile mortice nightlatch case	SS

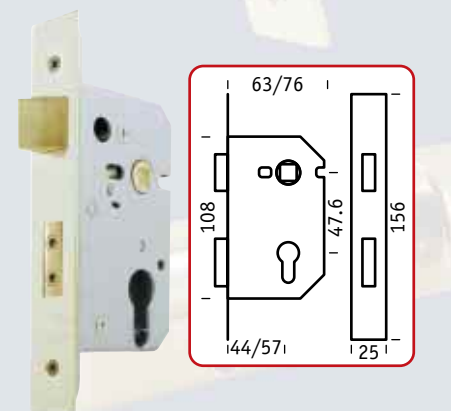
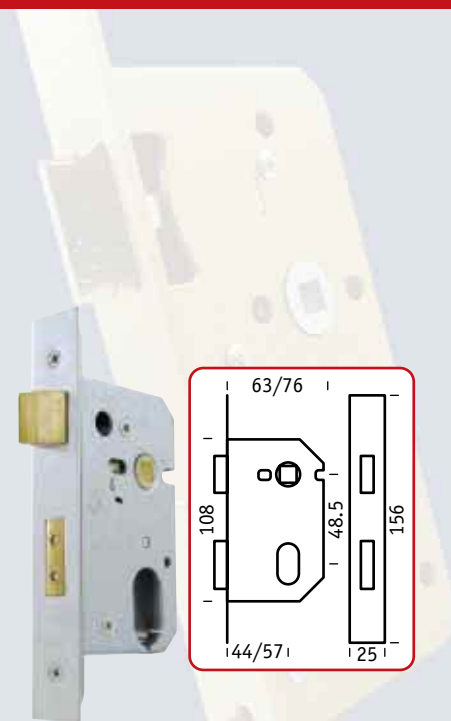

Also available Oval Profile
48.5mm centres

Architectural Lockcases & Cylinders

Architectural Cylinder Mortice Deadlock Cases

- Hardened steel rollers in brass deadbolt
- Box striking plate to complement forend
- Hammered silver steel case
- 10 per box complete with fixing screws

Oval Profile Mortice Deadlock Cases

AR/M-705-63-BR	63mm Oval profile mortice deadlock case	BR
AR/M-705-63-SC	63mm Oval profile mortice deadlock case	SC
AR/M-705-75-BR	76mm Oval profile mortice deadlock case	BR
AR/M-705-75-SC	76mm Oval profile mortice deadlock case	SC

Euro Profile Mortice Deadlock Cases

AR/M-706-63-BR	63mm Euro profile mortice deadlock case	BR
AR/M-706-63-SC	63mm Euro profile mortice deadlock case	SC
AR/M-706-75-BR	76mm Euro profile mortice deadlock case	BR
AR/M-706-75-SC	76mm Euro profile mortice deadlock case	SC

Rebate Sets to Suit: AR/M-705/706 Deadlocks

AR/M-730-13-BR	13mm Rebate set	BR
AR/M-730-13-SC	13mm Rebate set	SC
AR/M-730-25-BR	25mm Rebate set	BR
AR/M-730-25-SC	25mm Rebate set	SC

Cylinder Escape Deadlock Cases

- Deadbolt withdrawn by key from both sides or internal half set of lever handles
- Hardened steel rollers in brass deadbolt
- Striking plate to match forend
- 8mm brass follower

AR/BS-2507-EP-BR	76mm Euro profile escape deadlock case	BR
AR/BS-2507-EP-SS	76mm Euro profile escape deadlock case	SS
AR/BS-2507-OP-BR	76mm Oval profile escape deadlock case	BR
AR/BS-2507-OP-SS	76mm Oval profile escape deadlock case	SS

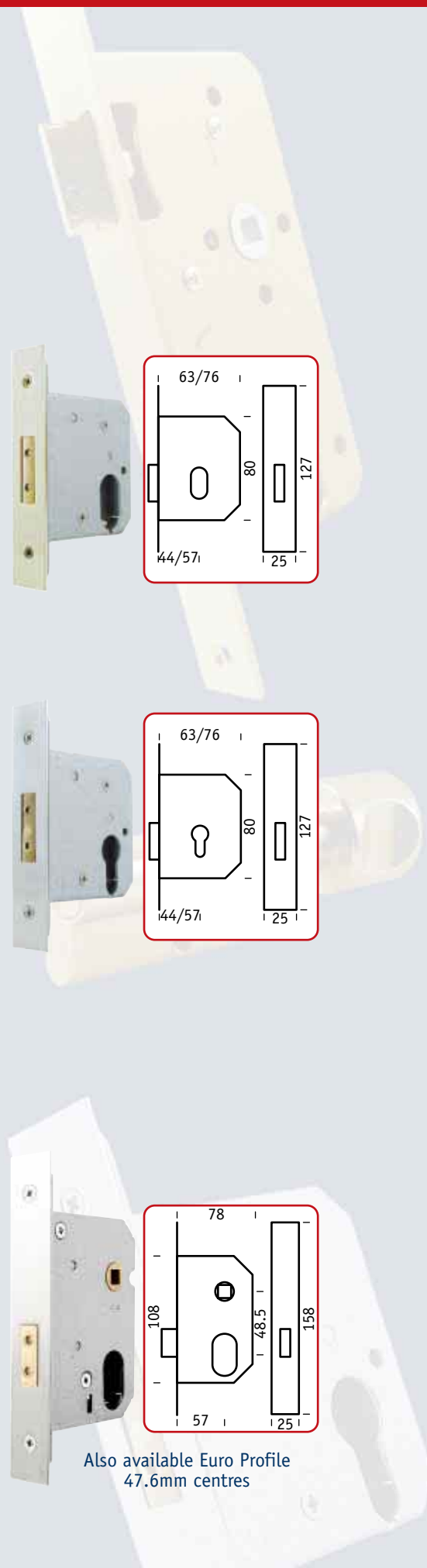

Also available Euro Profile
47.6mm centres

Architectural Mortice Latches/Bathroom Locks

- Heavy duty springing to suit unsprung furniture
- Easily reversible brass latch bolt
- Suitable for bolt through furniture (38mm centres)
- Flat striking plate to complement forend
- Hammered silver steel case
- 10 per box complete with fixing screws

Upright Mortice Latch (8mm Follower)

AR/M-707-63-BR	63mm Upright mortice latch	BR
AR/M-707-63-SC	63mm Upright mortice latch	SC
AR/M-707-75-BR	75mm Upright mortice latch	BR
AR/M-707-75-SC	75mm Upright mortice latch	SC

Square Case Mortice Latch (8mm Follower)

AR/M-700M-67-BR	67mm Square case architectural mortice latch	BR
AR/M-700M-67-SC	67mm Square case architectural mortice latch	SC
AR/M-700M-76-BR	76mm Square case architectural mortice latch	BR
AR/M-700M-76-SC	76mm Square case architectural mortice latch	SC
AR/M-700M-100-BR	100mm Square case architectural mortice latch	BR
AR/M-700M-100-SC	100mm Square case architectural mortice latch	SC

Bathroom Locks (5mm Snib Follower)

AR/M-723-63-BR	63mm Bathroom lock	BR
AR/M-723-63-SC	63mm Bathroom lock	SC
AR/M-723-75-BR	75mm Bathroom lock	BR
AR/M-723-75-SC	75mm Bathroom lock	SC

Square Case Bathroom Deadbolt (5mm Follower)

AR/M-731-67-BR	67mm Square case architectural bathroom deadbolt	BR
AR/M-731-67-SC	67mm Square case architectural bathroom deadbolt	SC
AR/M-731-76-BR	76mm Square case architectural bathroom deadbolt	BR
AR/M-731-76-SC	76mm Square case architectural bathroom deadbolt	SC
AR/M-731-100-BR	100mm Square case architectural bathroom deadbolt	BR
AR/M-731-100-SC	100mm Square case architectural bathroom deadbolt	SC

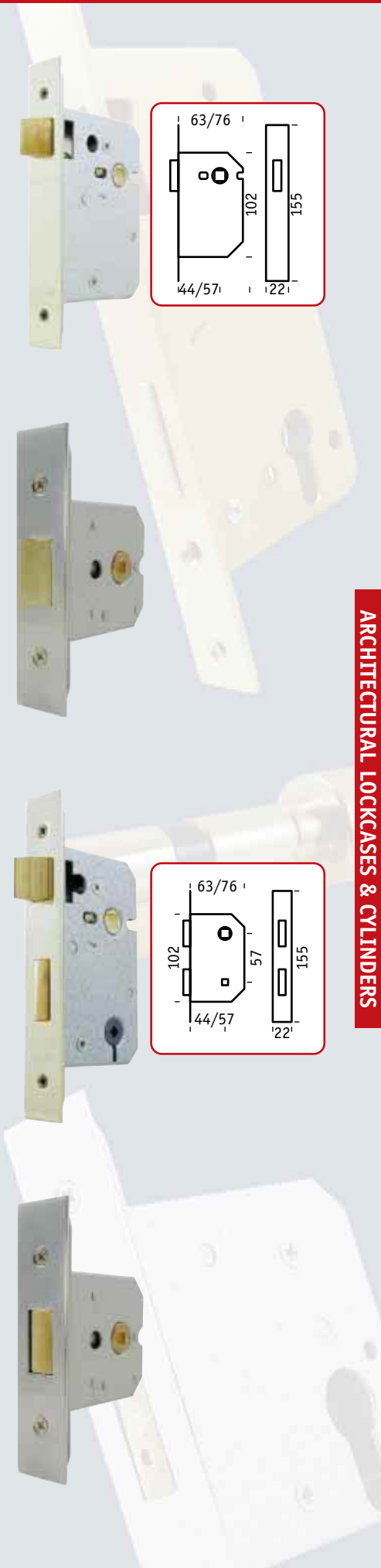

Architectural Lockcases & Cylinders

CES Softline cylinders are available as standard differ stock, keyed alike or master keyed to individual requirements. Because CES Softline cylinders operate on 6 pins and multiple sections, they are equally suitable for complex grand master keyed suites.

The diagrams on these pages give a guide to the many keying arrangements possible with CES Softline cylinders. There is often confusion between keyed alike locks and a straight master keyed system. In a keyed alike arrangement all the locks operate using the **same** key. However in a straight master keyed suite all the locks can operate off **different** keys, but another key (called the master key) will open them all.

Master keyed suites often have Sub Suites. Examples of this could be seen in a small hotel where the hotel manager has a **master key** to open **all** doors. A

chambermaid could have a **sub master** to open a range of bedroom doors only but none of the offices for instance. An individual room key in this arrangement is referred to as a **servant key**.

Varying degrees of complexity can be achieved to suit a variety of needs and examples of these are shown in the accompanying diagrams.

The common entrance suite is useful in student's accommodation or a block of flats. This suite removes the need to hold two keys, i.e. one for the front door and one for an individual room. A common entrance key will open the front door **and** the individual room.

In any master keyed suite, regardless of size it is wise to look ahead to future growth. Provision can be made in the suite for extensions at a later date. This is always easier to do at the time the suite is created.



Keyed Alike Suites (KA)

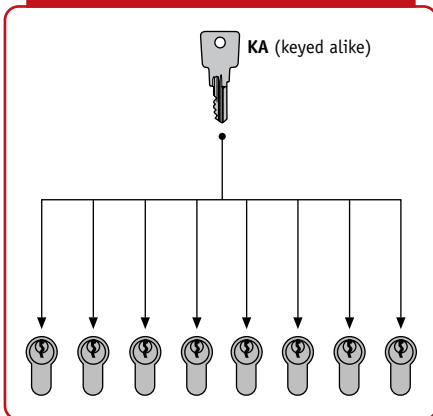

In keyed alike arrangements all the cylinders are operated by the same key. The CES Softline rim cylinders can also be keyed alike to the euro profile and oval cylinders. This is useful where a combination of mortice lock cases and cylinder rim nightlatches are being used.

Common Entrance Suite (CL)

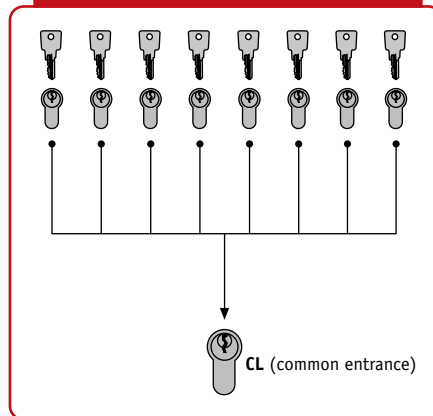

Common entrance suites are designed to enable a tenant to use the same key for his own private doors as well as doors common to other residents within the same buildings. The common entrance feature can be incorporated within any master key suite.



Master Key Suites (MK)

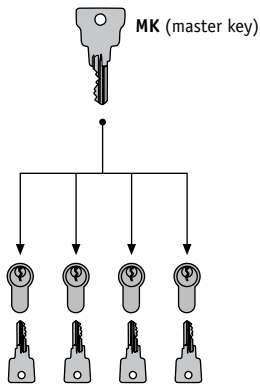

In Master key suites, a group of cylinders, each equipped with an individual key, is also operated by one special key known as the master key. Keyed alike groups can also be incorporated into any master key suite.

Grand Master Key Suites (GMK)

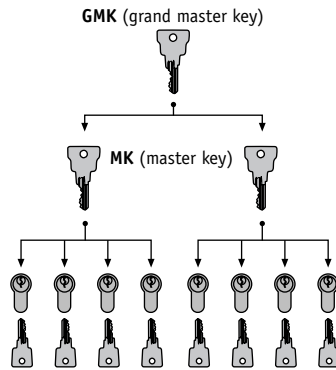

Grand master key installations are used when it is necessary to have more than one MK group within the same buildings complex. In these instances all cylinders irrespective of their MK group, are controlled by one key known as the grand master key.

Great Grand Master Key Suites (GGMK)

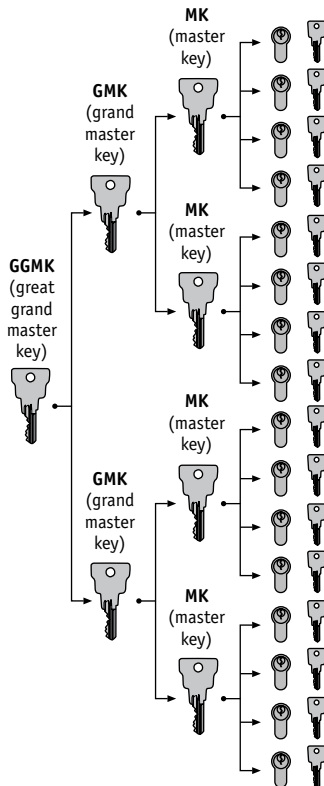

Great grand master key suites are used when it is necessary to have more than one GMK group within the same buildings complex. In these instances all cylinders, irrespective of their MK/GMK group, are controlled by one key known as the great grand master key.



Architectural Lockcases & Cylinders

CES Softline 6 Pin Patented System

CES Softline Cylinders are available as standard differ stock and can be assembled keyed alike or Master keyed. Softline is available in multi-profile sections and is therefore particularly suitable for complex grand master keyed systems.

- 20 year patent protection (from 1997)
- Exclusive patented keyways
- Key blanks not issued
- Drill and pick resistant
- 3 keyed

Euro Profile Double Cylinders

CES-810SP6-A-PB	63mm Euro profile double cylinder	PB
CES-810SP6-A-NP	63mm Euro profile double cylinder	NP
CES-810SP6-B-PB	71mm Euro profile double cylinder	PB
CES-810SP6-B-NP	71mm Euro profile double cylinder	NP
CES-810SP6-C-PB	81mm Euro profile double cylinder	PB
CES-810SP6-C-NP	81mm Euro profile double cylinder	NP

Euro Profile Cylinders and Turn

CES-815SP6-A-PB	63mm Euro profile cylinder and turn	PB
CES-815SP6-A-NP	63mm Euro profile cylinder and turn	NP
CES-815SP6-B-PB	71mm Euro profile cylinder and turn	PB
CES-815SP6-B-NP	71mm Euro profile cylinder and turn	NP
CES-815SP6-C-PB	81mm Euro profile cylinder and turn	PB
CES-815SP6-C-NP	81mm Euro profile cylinder and turn	NP

Euro Profile Single (Half) Cylinders

- The cam on the single cylinder is adjustable to 8 positions, in 45 degree increments

CES-851SP6-A-PB	40.5mm Euro profile single cylinder	PB
CES-851SP6-A-NP	40.5mm Euro profile single cylinder	NP
CES-851SP6-B-PB	45.5mm Euro profile single cylinder	PB
CES-851SP6-B-NP	45.5mm Euro profile single cylinder	NP
CES-851SP6-C-PB	50.5mm Euro profile single cylinder	PB
CES-851SP6-C-NP	50.5mm Euro profile single cylinder	NP



Master Key

Servant Key

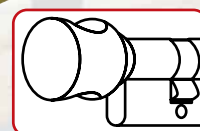
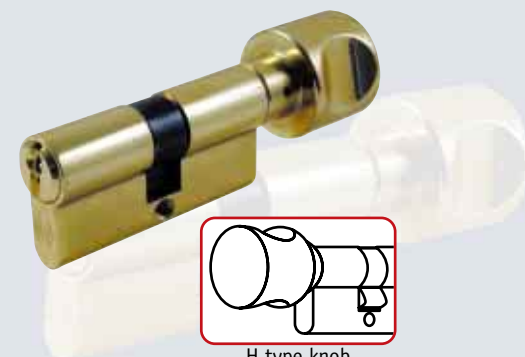

H type knob



Oval Profile Double Cylinders

CES-710SP6-A-PB	63mm Oval profile double cylinder	PB
CES-710SP6-A-NP	63mm Oval profile double cylinder	NP
CES-710SP6-B-PB	71mm Oval profile double cylinder	PB
CES-710SP6-B-NP	71mm Oval profile double cylinder	NP
CES-710SP6-C-PB	81mm Oval profile double cylinder	PB
CES-710SP6-C-NP	81mm Oval profile double cylinder	NP

Oval Profile Cylinder and Turn

CES-715SP6-A-PB	63mm Oval profile cylinder and turn	PB
CES-710SP6-A-NP	63mm Oval profile cylinder and turn	NP
CES-715SP6-B-PB	71mm Oval profile cylinder and turn	PB
CES-715SP6-B-NP	71mm Oval profile cylinder and turn	NP
CES-715SP6-C-PB	81mm Oval profile cylinder and turn	PB
CES-715SP6-C-NP	81mm Oval profile cylinder and turn	NP

Oval Profile Single (Half) Cylinders

- The cam on the single cylinder is adjustable to 8 positions, in 45 degree increments

CES-751SP6-A-PB	40.5mm Oval profile single cylinder	PB
CES-751SP6-A-NP	40.5mm Oval profile single cylinder	NP
CES-751SP6-B-PB	45.5mm Oval profile single cylinder	PB
CES-751SP6-B-NP	45.5mm Oval profile single cylinder	NP
CES-751SP6-C-PB	50.5mm Oval profile single cylinder	PB
CES-751SP6-C-NP	50.5mm Oval profile single cylinder	NP

Rim Cylinder

CES-30SP6-A-PB	Rim Cylinder	PB
CES-30SP6-A-NP	Rim Cylinder	NP

Round Mortice (Threaded) Cylinder

CES-5875SP6-A-NP	Rounded Mortice Cylinder	NP
-------------------------	--------------------------	-----------

Padlocks

CES-215N-58	58mm Brass padlock, SCP finish hardened stainless steel shackle	SCP
--------------------	---	------------

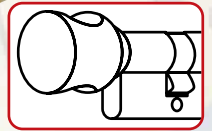

H type knob

Architectural Lockcases & Cylinders

CES KM6 6 Pin Copyright Protected System

The KM6 range of cylinders gives the end user all the features of the Softline range whilst adding steel inserts to give even greater protection against drilling/picking. KM6 also enjoys the benefit of unlimited copyright protection which means keys will never be available without authorisation from the end user.

All suites are custom built to the users own requirements at the CES factory allowing for highly complex suites to be built quickly by their expert locksmiths.

All KM6 cylinders are to special order only.

CES KM6 6 Pin Copyright Protected System

- UNLIMITED COPYRIGHT PROTECTION
- Exclusive patented keyway
- Key blanks not issued
- Anti drill/anti pulling protection with steel pins and inserts
- 3 keyed
- Multiple key sections

Euro Profile Double Cylinders

810KM6	63mm Euro profile double cylinder	PB
810SP6	63mm Euro profile double cylinder	NP
810KM6	71mm Euro profile double cylinder	PB
810KM6	71mm Euro profile double cylinder	NP
810KM6	81mm Euro profile double cylinder	PB
810KM6	81mm Euro profile double cylinder	NP

Euro Profile Cylinders and Turn

815KM6	63mm Euro profile cylinder and turn	PB
815KM6	63mm Euro profile cylinder and turn	NP
815KM6	71mm Euro profile cylinder and turn	PB
815KM6	71mm Euro profile cylinder and turn	NP
815KM6	81mm Euro profile cylinder and turn	PB
815KM6	81mm Euro profile cylinder and turn	NP

Euro Profile Single (Half) Cylinders

- The cam on the single cylinder is adjustable in 8 position, in 45 degree increments

851KM6	40.5mm Euro profile single cylinder	PB
851KM6	40.5mm Euro profile single cylinder	NP
851KM6	45.5mm Euro profile single cylinder	PB
851KM6	45.5mm Euro profile single cylinder	NP
851KM6	50.5mm Euro profile single cylinder	PB
851KM6	50.5mm Euro profile single cylinder	NP

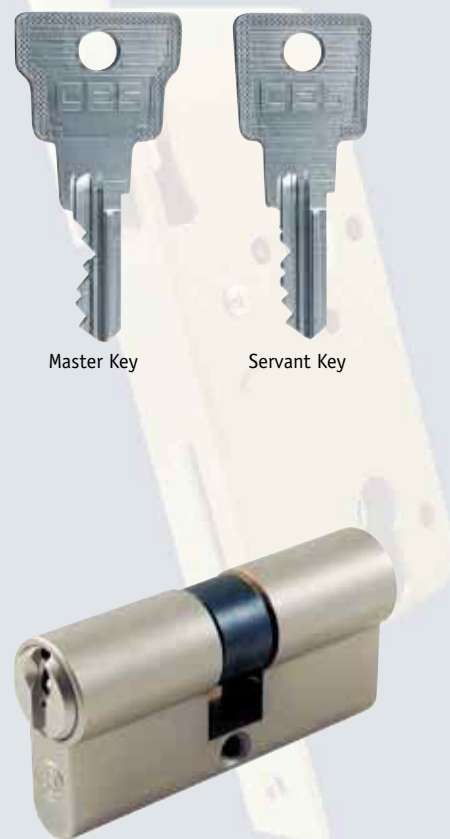

Master Key

Servant Key

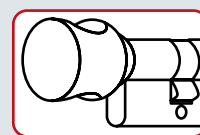

H type knob



Oval Profile Double Cylinders

710KM6	63mm Oval profile double cylinder	PB
710KM6	63mm Oval profile double cylinder	NP
710KM6	71mm Oval profile double cylinder	PB
710KM6	71mm Oval profile double cylinder	NP
710KM6	81mm Oval profile double cylinder	PB
710KM6	81mm Oval profile double cylinder	NP

Oval Profile Cylinder and Turn

710KM6	63mm Oval profile cylinder and turn	PB
710KM6	63mm Oval profile cylinder and turn	NP
715KM6	71mm Oval profile cylinder and turn	PB
715KM6	71mm Oval profile cylinder and turn	NP
715KM6	81mm Oval profile cylinder and turn	PB
715KM6	81mm Oval profile cylinder and turn	NP

Oval Profile Single (Half) Cylinders

- The cam on the single cylinder is adjustable in 8 position, in 45 degree increments

751KM6	40.5mm Oval profile single cylinder	PB
751KM6	40.5mm Oval profile single cylinder	NP
751KM6	45.5mm Oval profile single cylinder	PB
751KM6	45.5mm Oval profile single cylinder	NP
751KM6	50.5mm Oval profile single cylinder	PB
751KM6	50.5mm Oval profile single cylinder	NP

Rim Cylinder

30KM6	Rim Cylinder	PB
30KM6	Rim Cylinder	NP

Round Mortice (Threaded) Cylinder

5875KM6	Rounded Mortice Cylinder	NP
----------------	--------------------------	-----------

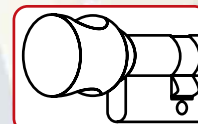

H type knob



Architectural Lockcases & Cylinders

ARRONE Convenience Stock Suite - 6 Pin

- The Arrone 6 Pin stock suite of cylinders offers the convenience of an “off the shelf” master keyed system with very competitive pricing
- The suite is a straight master keyed system with no sub suites
- Key blanks are available
- Finishes: Satin Chrome/Polished brass

Euro Profile Cylinders

AR/M-780-B-PB	70mm Euro Profile Double Cylinder	PB
AR/M-780-B-SC	70mm Euro Profile Double Cylinder	SC
AR/M-781-B-PB	70mm Euro Profile Cylinder and Turn	PB
AR/M-781-B-SC	70mm Euro Profile Cylinder and Turn	SC
AR/M-782-A-PB	50mm Euro Profile Single Cylinder	PB
AR/M-782-A-SCB	50mm Euro Profile Single Cylinder	SC

Oval Profile Cylinders

AR/M-783-B-PB	70mm Oval Profile Double Cylinder	PB
AR/M-783-B-SC	70mm Oval Profile Double Cylinder	SC
AR/M-784-B-PB	70mm Oval Profile Cylinder and Turn	PB
AR/M-784-B-SC	70mm Oval Profile Cylinder and Turn	SC
AR/M-785-A-PB	50mm Oval Profile Single Cylinder	PB
AR/M-785-A-SC	50mm Oval Profile Single Cylinder	SC

Rim Cylinders

AR/M-786-PB	Rim Cylinder	PB
AR/M-786-SC	Rim Cylinder	SC

Keys & Blanks

AR/M-780-MK	Master key
AR/M-780-KB	Blank



Hinges

Hinges

Recognised internationally as America's leading manufacturer of Hinges and Ironmongery the Hager Hinge Company has remained a family business for over 140 years. With four manufacturing plants in the USA and Canada, the company still follows its founding principle -

Quality service, Today as yesterday.

BB6191 Ball Bearing Stainless Steel Hinges

- 2 Ball Bearing Stainless Steel Hinges
- Successfully tested in accordance with the proposed new European draft specification pr EN1935: October 1998 and has achieved grade 13 (Severe duty - 120kg door mass 200,000 cycle endurance) Equivalent to BS7352: 1990 class 9
- Ball races and pin manufactured from high grade 304 Stainless Steel casing
- High performance seated/fixed bearings
- 1 piece removable stainless steel pin
- Template drilled and countersunk
- Recommended for internal and external use
- High viscosity oil - stainfree
- Supplied with stainless steel screws
- 10 year guarantee (when fitted to manufacturers instructions)

HABB6191/1	4" x 3" x 3mm (102mm x 76mm x 3mm)	SSS
HABB6191/2	4" x 3" x 3mm (102mm x 76mm x 3mm)	PSS
HABB6191/3	4" x 3.5" x 3mm (102mm x 89mm x 3mm)	SSS
HABB6191/4	4" x 4" x 3mm (102mm x 102mm x 3mm)	SSS
HABB6191/5	5" x 3.5" x 3mm (127mm x 89mm x 3mm)	SSS

Radius Corners and Security Studs:

- BB6191 Hinges can be supplied at extra cost with radius corners/security studs to special order (Minimum order quantity 24 pair)
- Security studs prevent the door being removed from the frame in the event the of the pin being taken out

6191 Plain Bearing Stainless Steel Hinges

- Removable pin c/w stainless steel screws

HA6191/3	4" x 3" x 3mm (102mm x 76mm x 3mm)	SSS
HA6191/4	4" x 3.5" x 3mm (102mm x 89mm x 3mm)	SSS
HA6191/5	4" x 4" x 3mm (102mm x 102mm x 3mm)	SSS

Radius Corners and Security Studs:

- 6191 Hinges can be supplied at extra cost with radius corners/security studs to special order (Minimum order quantity 24 pair)
- Security studs prevent the door being removed from the frame in the event the of the pin being taken out

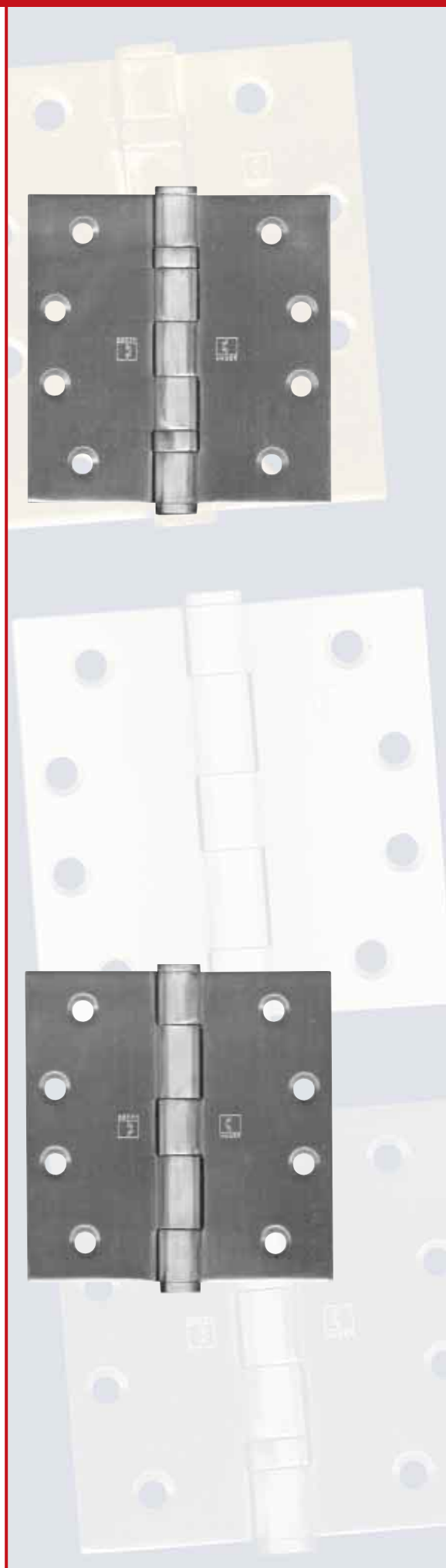

1250 Single Action Spring Hinges

- Supplied with screws

HA1250/1	3.5" x 3.5" (89mm x 89mm) 45Kg max. door weight	SC
HA1250/1A	3.5" x 3.5" (89mm x 89mm) 45Kg max. door weight	SB
HA1250/1B	3.5" x 3.5" (89mm x 89mm) 45Kg max. door weight	PB
HA1250/2	4" x 4" (102mm x 102mm) 60Kg max. door weight	SC
HA1250/2A	4" x 4" (102mm x 102mm) 60Kg max. door weight	SB
HA1250/2B	4" x 4" (102mm x 102mm) 60Kg max. door weight	PB
HA1250/3	4.5" x 4" (115mm x 102mm) 70Kg max. door weight	SC
HA1250/3A	4.5" x 4" (115mm x 102mm) 70Kg max. door weight	SB
HA1250/3B	4.5" x 4" (115mm x 102mm) 70Kg max. door weight	PB

BB1279 2 Ball Bearing Steel Butt Hinges

- Features removable steel pin c/w screws
- Ideal for use as a support hinge to 1250 spring hinges

HABB1279/1	4" x 3.5" (102mm x 89mm)	SC
HABB1279/2	4" x 3.5" (102mm x 89mm)	SB
HABB1279/3	4" x 4" (102mm x 102mm)	SC
HABB1279/4	4.5" x 4" (115mm x 102mm)	SC
HABB1279/5	4.5" x 4.5" (115mm x 115mm)	SC

1279 Plain Bearing Steel Hinges

- Removable steel pin c/w screws

HA1279/1	3.5" x 3.5" (89mm x 89mm) 45Kg max. door weight	SC
HA1279/1A	3.5" x 3.5" (89mm x 89mm) 45Kg max. door weight	SB
HA1279/1B	3.5" x 3.5" (89mm x 89mm) 45Kg max. door weight	PB

BB1168 4 Ball Bearing Steel Butt Hinges

- Removable pin c/w screws
- Heavy duty suitable for doors 77-120kg

HABB1168/1	4.5" x 4.5" (115mm x 115mm)	PB
HABB1168/2	4.5" x 4.5" (115mm x 115mm) Prime coat	PC-B
HABB1168/3	4.5" x 4.5" (115mm x 115mm)	SC

BB1191 2 Ball Bearing Stainless Steel Butt Hinges

- Removable pin c/w screws
- Heavy duty, high frequency uses 120Kg doors

HABB1191	4" x 3.5" (102mm x 89mm)	SSS
-----------------	--------------------------	------------

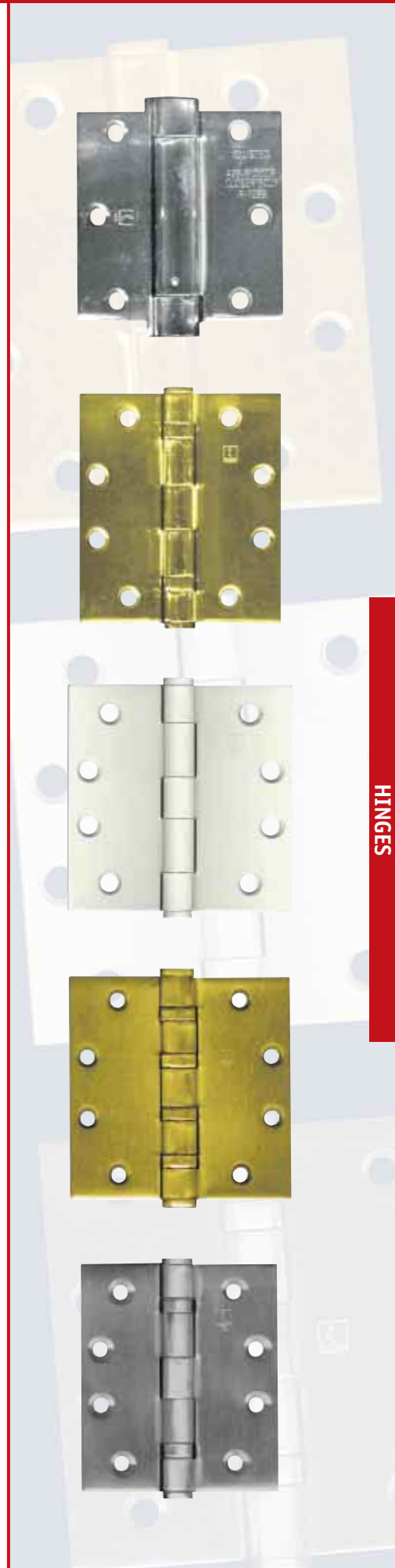

Pivot Sets

500 Series Single Action Pivot Set

Set consists of:

- Top Head Pivot
- Bottom Floor Pivot

Completely concealed, easy installation, minimum wear, adjustable alignment. Fully reversible pivot opens door to 105° maximum and is designed for 45mm maximum thickness door, maximum door weight 40Kg, Maximum door size 213cm x 91cm (7' x 3'). Frame not to have door stop at head and pivot jamb. Can be used with overhead door closer or holder.

Construction:

Heavy cast hard brass rack boxes, non magnetic stainless steel gears, 13mm dia cold rolled steel pintles and cast iron door brackets.

Standards:

Conforms to ANSI A2792

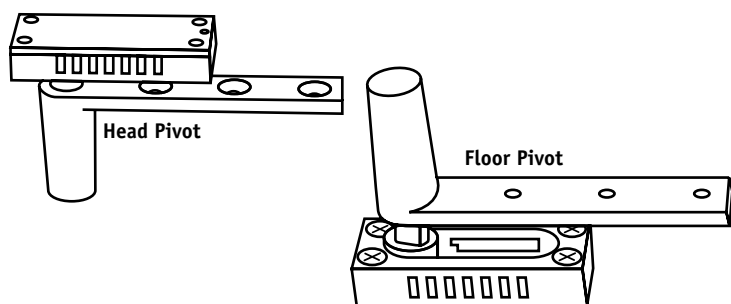

HA500 Single action pivot set

SSS

600 Series Camtrol Double Action Pivot Set

Mortice application in wood floor

Rescue Hardware for hospitals and nursing homes.

Set consists of:

- Top Head Pivot
- Bottom Floor Pivot
- Door Release

Suitable for use on wood or metal doors, max door weight 50kg, maximum door size 213mm x 91cm (7' x 3').

Camtrol action makes possible snug application without rounding of door edge, only three moving parts in each pivot.

Standards:

Conforms to ANSI A2742

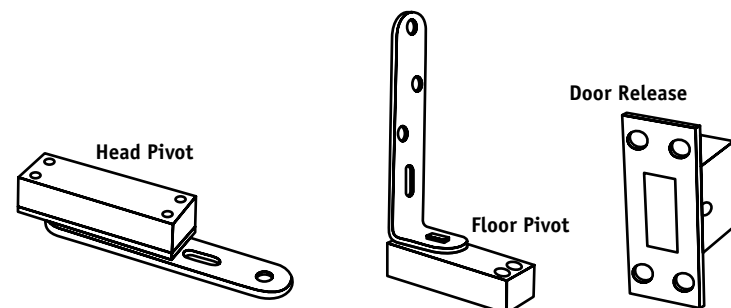

HA600 Double action pivot set. Mortice application in wood floor.

SSS

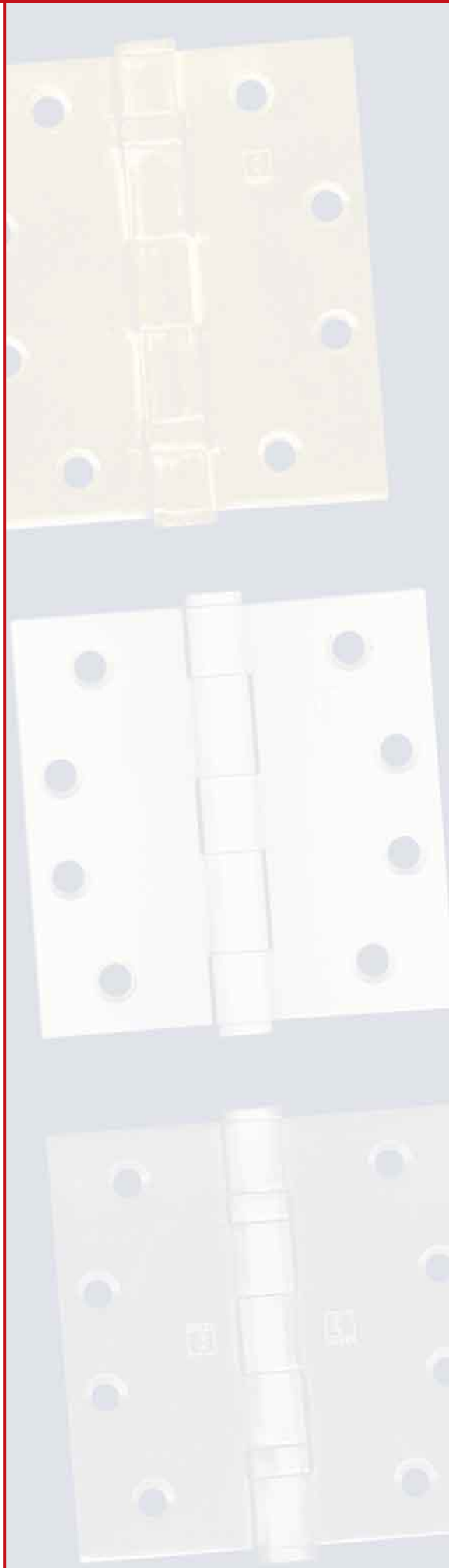

611 Series Camtrol Double Action Pivot Set

Mortise application in masonry floor

Rescue Hardware for hospitals and nursing homes.

Set consists of:

- Top Head Pivot
- Bottom Floor Pivot
- Door Release

Suitable for use on wood or metal doors, maximum door weight 50Kg, maximum door size 213cm x 91cm (7' x 3').

Camtrol action makes possible snug application with out rounding of door edge, only three moving parts in each pivot.

Standards:

Conforms to ANSI A2742

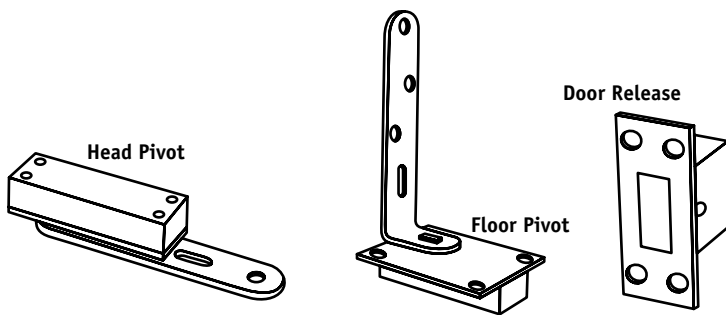

HA611 Double action pivot set. Mortise application in masonry floor.

SSS

612 Series Camtrol Double Action Pivot Set

Surface application in masonry/wood floor

Rescue Hardware for hospitals and nursing homes.

Set consists of:

- Top Head Pivot
- Bottom Floor Pivot
- Door Release

Suitable for use on wood or metal doors, max door weight 50kg, maximum door size 213mm x 91cm (7' x 3').

Camtrol action makes possible snug application with out rounding of door edge, only three moving parts in each pivot.

Standards:

Conforms to ANSI A2742

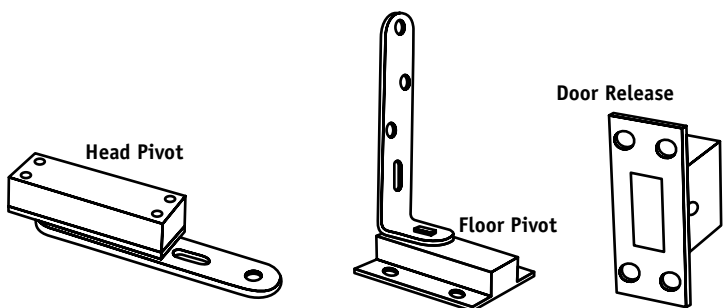

HA612 Double action pivot set. Surface application in masonry/wood floor.

SSS

Hinges

ARRONE Colour Coated Steel Butt Hinges

- Colour coated steel butt hinges supplied complete with screws to compliment the Hoppe range of nylon door furniture and accessories
- Available in 11 RAL colours

AR628A	3" (75mm) 1838 Lt patt steel butt hinge c/w screws
AR628B	4" (100mm) 1838 Lt patt steel butt hinge c/w screws
AR628C	3" (75mm) 451 Heavy patt steel butt hinge c/w screws
AR628D	4" (100mm) 451 Heavy patt steel butt hinge c/w screws

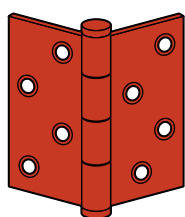

Red (Rouge)
RAL 3003

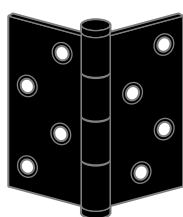

Black (Ebony)
RAL 9005

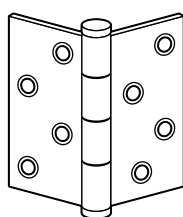

Diamond White
RAL 9016

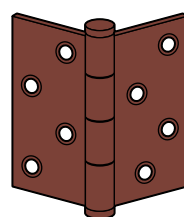

Claret
RAL 3005

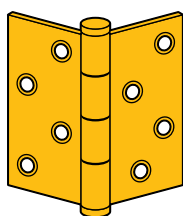

Golden Yellow
RAL 1004

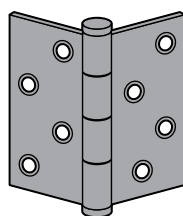

Dove Grey
RAL 7036

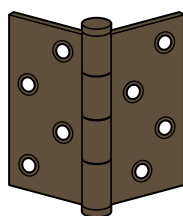

Brown (Sienna)
RAL 8017

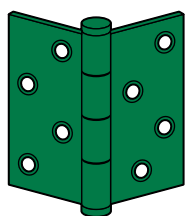

Green (Viridian)
RAL 6016

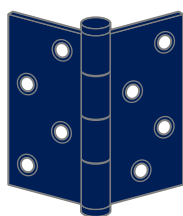

Midnight Blue
RAL 5003

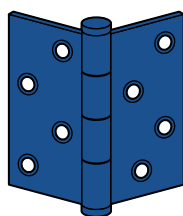

Cobalt Blue
RAL 5002

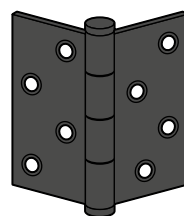

Flint Grey
RAL 7043

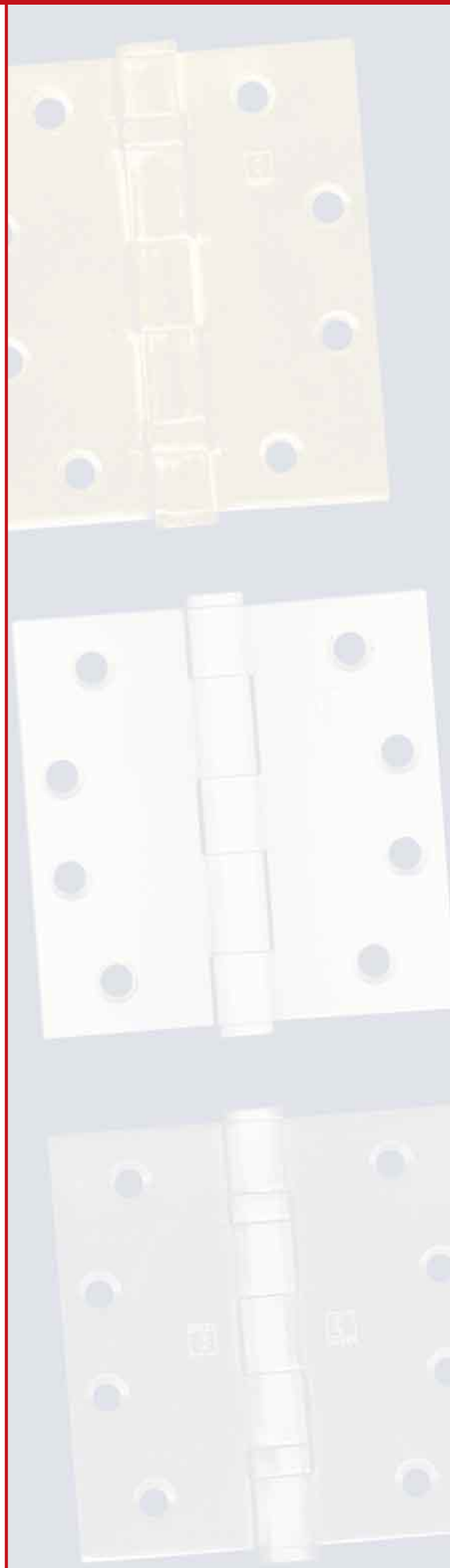

ARRONE

Disabled Fittings

Disabled Fittings

Round Bar Lever Furniture (Sprung)

AR750/10

Lever on rose

SAA

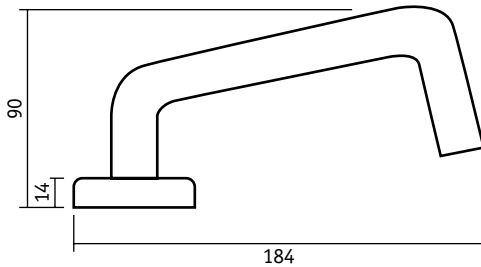

AR750/11	Long plate latch furniture	SAA
AR750/12	Lock furniture	SAA
AR750/13	Euro profile lock furniture	SAA
AR750/14	Oval profile lock furniture	SAA
AR750/15	Bathroom furniture (extended turn)	SAA

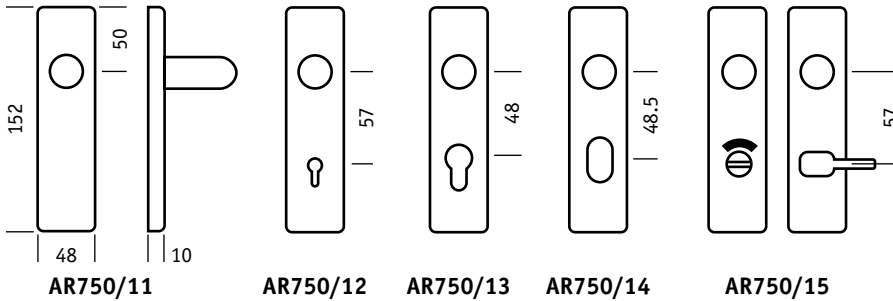

Escutcheons, Turn & Indicator

AR200/26	Lever key escutcheon 52mm diameter, 38mm fixing centres	SAA
AR200/27	Euro profile escutcheon 52mm diameter, 38mm fixing centres	SAA
AR200/28	Oval profile escutcheon 52mm diameter, 38mm fixing centres	SAA
AR200/29D	Turn & indicator, 5mm spindle 52mm diameter, 38mm fixing centres	SAA
AR750/29	Turn & indicator, 5mm spindle 52mm diameter, 38mm fixing centres	SAA

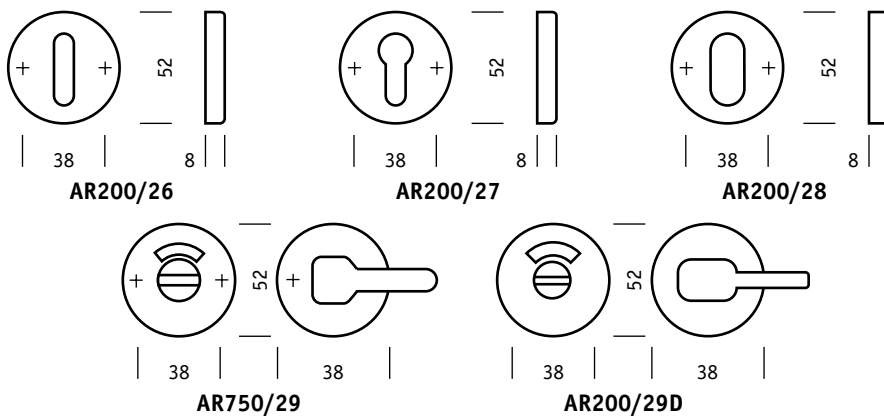

Accessories

AR763/SS	Folding grab rail	SS
AR763/PC	Folding grab rail	WHITE
AR764/SS	Back rest	SS
AR764/PC	Back rest	WHITE
AR765/SS	Grab/towel rail	SS
AR765/PC	Grab/towel rail	WHITE
AR766/SS	Handrail bracket	SS
AR766/PC	Handrail bracket	WHITE

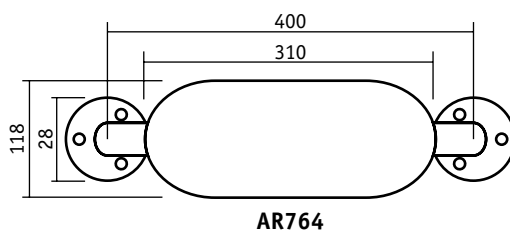
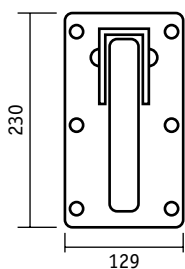

AR764

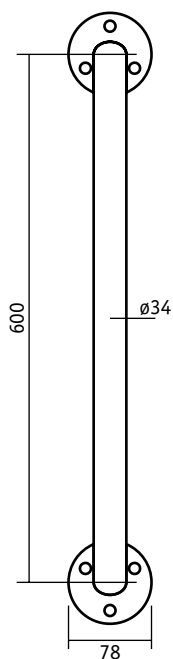
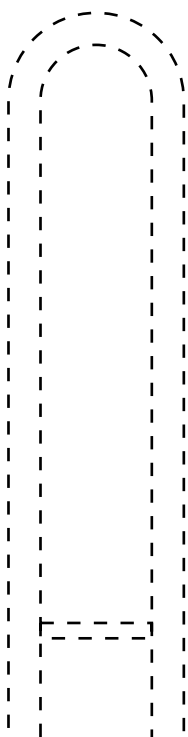

AR765

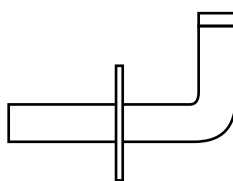

AR766

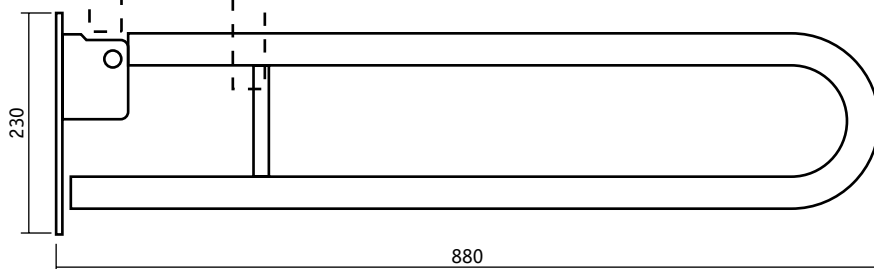

AR763

ARRONE

Premium Aluminium

Door Furniture

Our Premium Aluminium Range features a series of quality aluminium levers both face fix and concealed fix manufactured by Europe's leading door furniture manufacturer **HOPPE**. These levers offer excellent quality at competitive prices and are suitable for everyday use in domestic and light commercial applications.

To accompany our furniture we also offer a comprehensive range of accessories and fittings to fully complement the range.

The general finish of this range is satin anodised aluminium (SAA).

Face Fix Range (Sprung)

AR-103	Latch furniture	SAA
AR-103G	Latch furniture	GOLD
AR-104	Lock furniture	SAA
AR-104G	Lock furniture	GOLD
AR-104U	Oval cylinder lock furniture	SAA
AR-104UG	Oval cylinder lock furniture	GOLD
AR-104P	Euro profile cylinder lock furniture	SAA
AR-104PG	Euro profile cylinder lock furniture	GOLD
AR-105	Bathroom/privacy furniture	SAA
AR-105G	Bathroom/privacy furniture	GOLD

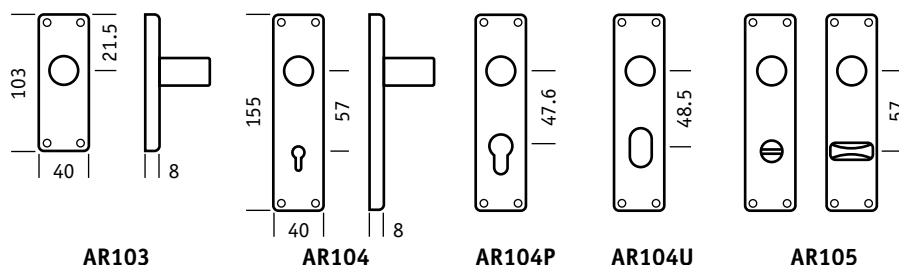

Concealed Fix Range (Sprung)

- Supplied complete with bolt fixings

AR-157CF	Latch furniture	SAA
AR-158BCF	Long plate latch furniture	SAA
AR-158BCF/G	Long plate latch furniture	GOLD
AR-158CF	Lock furniture	SAA
AR-158CF/G	Lock furniture	GOLD
AR-158U	Oval cylinder lock furniture	SAA
AR-158UGO	Oval cylinder lock furniture	GOLD
AR-158YP	Euro cylinder lock furniture	SAA
AR-158YPCF/G	Euro cylinder lock furniture	GOLD
AR-159	Bathroom furniture	SAA

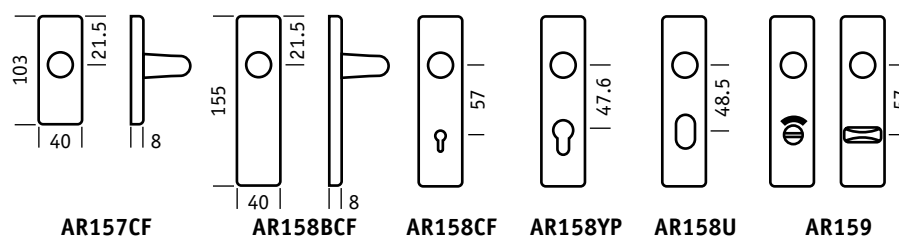

London Series (Sprung)

- Supplied complete with bolt fixings & screws
- Profile spindle 8mm

AR-170/10	Lever on round rose	SAA
AR-170/10G	Lever on round rose	GOLD

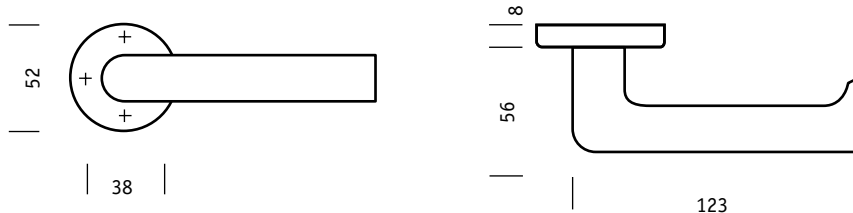

Concealed Fix Escutcheons

AR200/26	Lever key escutcheon 52mm diameter, 38mm fixing centres	SAA
AR200/27	Euro profile escutcheon 52mm diameter, 38mm fixing centres	SAA
AR200/28	Oval profile escutcheon 52mm diameter, 38mm fixing centres	SAA
AR200/30	Blind escutcheon 52mm diameter, 38mm fixing centres	SAA

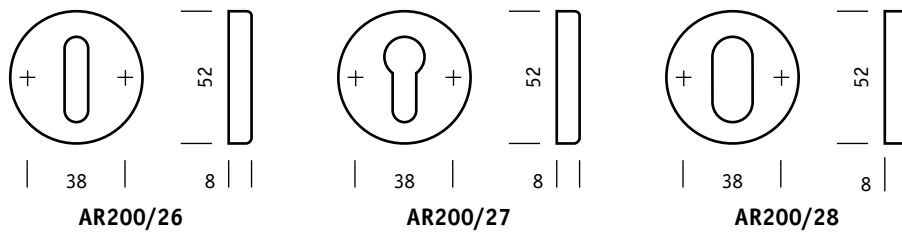

Bathroom Turn & Indicator

AR200/29	Bathroom turn & indicator 52mm diameter, 38mm fixing centres, 5mm spindle	SAA
AR200/29D	Disabled turn & indicator 52mm diameter, 38mm fixing centres, 5mm spindle	SAA

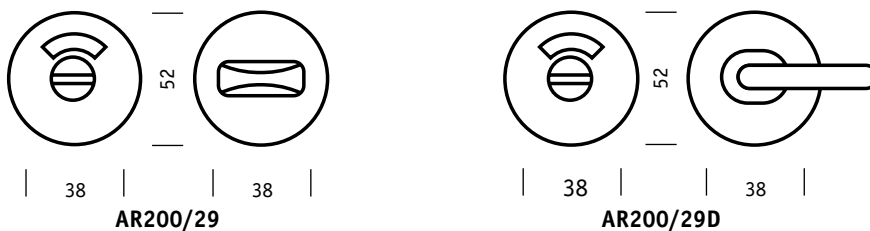

Escutcheons

AR-162	32mm Lever key escutcheon face fix	SAA
AR-163	32mm Lever key covered escutcheon face fix	SAA
AR-164	50mm Lever key escutcheon face fix	SAA
AR-164U	50mm Oval cylinder escutcheon face fix	SAA
AR-164YP	50mm Euro cylinder escutcheon face fix	SAA



PREMIUM ALUMINIUM

Pull Handles

Straight Pull Handles : $\phi 19$ mm

AR202/150CF	150mm concealed screw fixing	SAA
AR202/225CF	225mm concealed screw fixing	SAA
AR202/300CF	300mm concealed screw fixing	SAA
AR202/425CF	425mm concealed screw fixing	SAA

AR203/150BF	150mm bolt fixing	SAA
AR203/225BF	225mm bolt fixing	SAA
AR203/300BF	300mm bolt fixing	SAA
AR203/425BF	425mm bolt fixing	SAA

AR204/150BB	150mm back to back fixing	SAA
AR204/225BB	225mm back to back fixing	SAA
AR204/300BB	300mm back to back fixing	SAA

AR205/150P	150mm screw fix on plate	SAA
AR205/225P	225mm screw fix on plate	SAA
AR205/300P	300mm screw fix on plate	SAA

Cranked Pull Handles

AR-106A	225mm Cranked pull handle	SAA
AR-106B	300mm Cranked pull handle	SAA

Flat Face Pull Handles







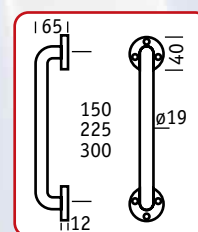
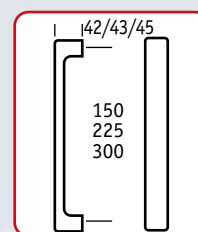
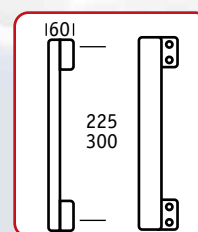
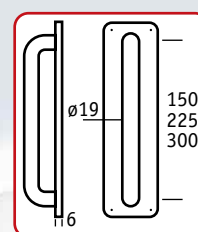
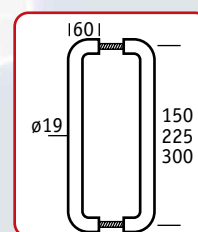
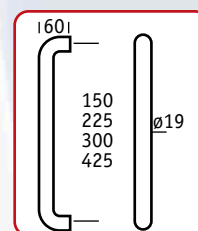
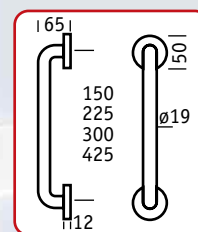





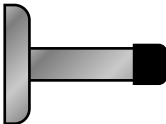
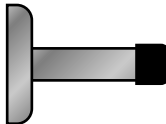
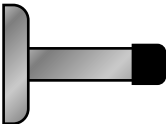
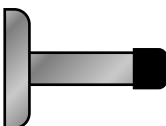

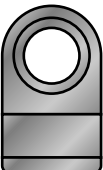
AR-107A	150mm Flat face pull handle	SAA
AR-107B	225mm Flat face pull handle	SAA
AR-107C	300mm Flat face pull handle	SAA

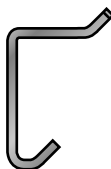
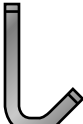
Face Fix Pull Handles

AR201/150FF	19mm x 150mm face fix pull handle	SAA
AR201/225FF	19mm x 225mm face fix pull handle	SAA
AR201/300FF	19mm x 300mm face fix pull handle	SAA



Accessories

<p>AR122 Oval shielded door stop</p> 	<p>AR123A 25mm shielded door stop</p> 	<p>AR123B 41mm shielded door stop</p> 
<p>AR130A 63mm round rose door stop concealed fix</p> 	<p>AR130B 76mm round rose door stop concealed fix</p> 	<p>AR130C 63mm round rose door stop face fix</p> 
<p>AR130D 76mm round rose door stop face fix</p> 	<p>AR162A 35mm black rubber door stop</p> 	<p>AR115 Cylinder pull for standard rim cylinder</p> 
<p>AR135A AR135A-GE 89mm strip pattern hat & coat hook SAA or Gold finishes</p> 	<p>AR135B AR135B-GE 125mm strip pattern hat & coat hook SAA or Gold finishes</p> 	<p>AR136 89mm hat & coat hook</p> 
<p>AR137 Wardrobe hook</p> 	<p>AR112A 250mm face fix letter plate sprung flap</p> 	<p>AR112B 300mm face fix letter plate sprung flap</p> 
<p>AR113A 250mm face fix letter plate Matt Silver sprung flap</p> 	<p>AR113B 300mm face fix letter plate Matt Silver sprung flap</p> 	<p>AR114A 250mm letter tidy Matt Silver</p> 
<p>AR114B 300mm letter tidy Matt Silver</p> 	<p>AR132A 19mm x 150mm flush bolt</p> 	<p>AR132B 19mm x 200mm flush bolt</p> 

Accessories

Accessories continued...

AR133A

50mm straight barrel bolts

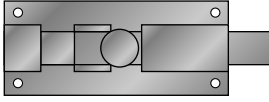

AR133B

63mm straight barrel bolts

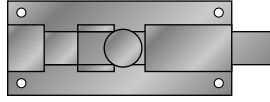

AR133C

75mm straight barrel bolts

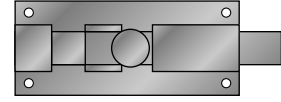

AR133D

100mm straight barrel bolts

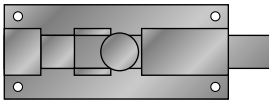

AR133E

150mm straight barrel bolts

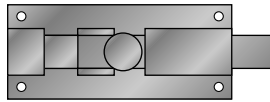

AR134A

75mm necked barrel bolts

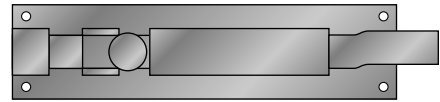

AR134B

100mm necked barrel bolts

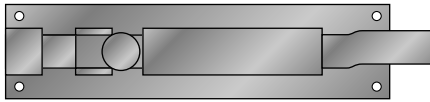

AR134C

150mm necked barrel bolts

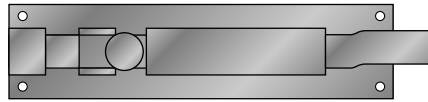

AR127A

10mm x 102mm cupboard 'D' handle



AR127B

10mm x 150mm cupboard 'D' handle (polished finish)



AR128

13mm x 150mm cupboard 'D' handle



AR129A

25mm cupboard knob



AR129B

32mm cupboard knob



AR129C

38mm cupboard knob



AR146

75mm x 305mm finger plate drilled and countersunk



AR146EP

32mm x 305mm finger plate engraved "Push" drilled and countersunk



AR124A

204mm casement stay



AR124B

254mm casement stay



AR124C

305mm casement stay



AR126

Casement fastener

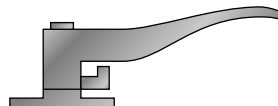

AR140

50mm numerals 0-9



AR131

Toilet roll holder



ARRONE

Premium Brassware

Door Furniture

A comprehensive range of Brass Levers and accessories by Europe's leading door furniture manufacturers including **HOPPE** .

Lever furniture is manufactured using the electro-phoretic process for long life and durability.

Offering excellent quality at value for money prices these elegant designs will enhance any modern home.

Victorian Straight Lever Furniture

AR-500/10	Lever on round rose
AR-500/11	Latch furniture
AR-500/12	Lock furniture
AR-500/15	Bathroom furniture
AR-500/16	Privacy furniture

Victorian Scroll Lever Furniture

AR-501/10	Lever on round rose
AR-501/11	Latch furniture
AR-501/12	Lock furniture
AR-501/15	Bathroom furniture
AR-501/16	Privacy furniture

Georgian Lever Furniture

AR-502/11	Latch furniture
AR-502/12	Lock furniture
AR-502/15	Bathroom furniture
AR-502/16	Privacy furniture

Victorian Shaped Scroll Lever Furniture

AR-503/11	Latch furniture
AR-503/12	Lock furniture
AR-503/15	Bathroom furniture
AR-503/16	Privacy furniture

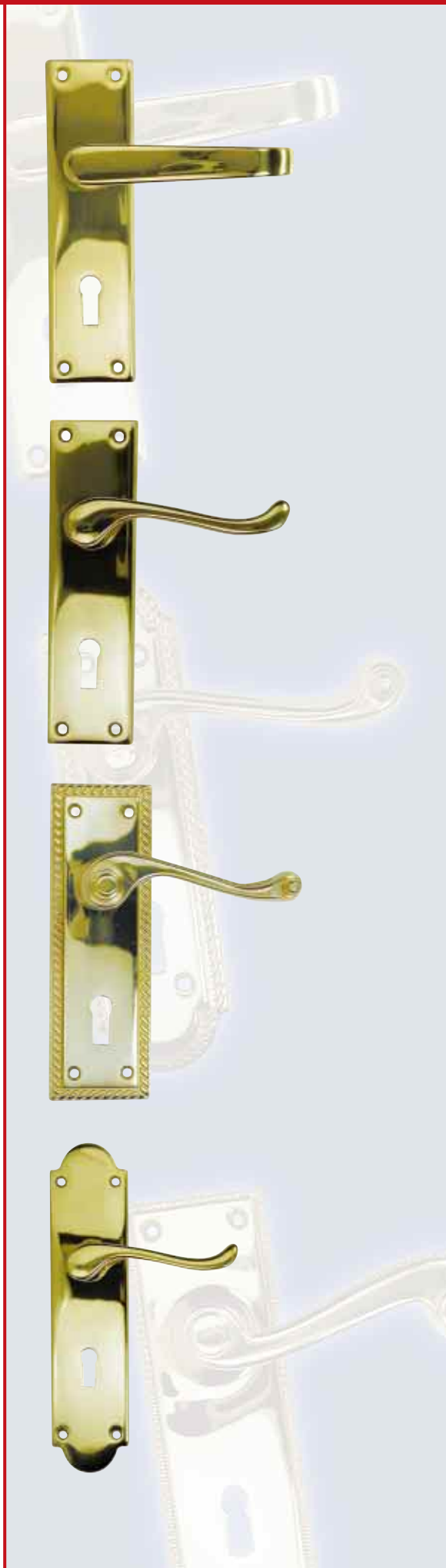

Shaped Georgian Lever Furniture

AR-504/11	Latch furniture
AR-504/12	Lock furniture
AR-504/15	Bathroom furniture

Shaped Beaded Lever Furniture

AR-505/10	Lever on round rose
AR-505/11	Latch furniture
AR-505/17	Short plate latch furniture
AR-505/12	Lock furniture
AR-505/15	Bathroom furniture

Regency Lever Furniture

AR-506/11	Latch furniture
AR-506/17	Short plate latch furniture
AR-506/12	Lock furniture
AR-506/15	Bathroom furniture

Escutcheons

AR-507	35mm Georgian face fix escutcheon
AR-508	35mm Georgian face fix covered escutcheon
AR-509	35mm Victorian face fix escutcheon
AR-510	35mm Victorian face fix covered escutcheon
AR-511	35mm Beaded face fix escutcheon
AR-512	35mm Beaded face fix covered escutcheon



Door Furniture & Accessories

Seattle Series

- Lever set with rose for interior doors thickness 32mm - 51mm (40mm with bathroom turn)
- Profile spindle 8mm
- Screw fixing

M168L/88-RF Sprung lever on round rose

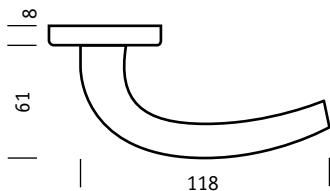
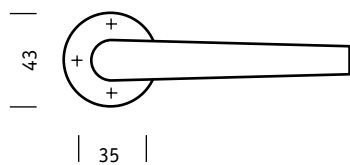

Escutcheons and Turns

M88S-OB	Lever key escutcheon
M88S-PZ	Euro profile escutcheon
M88S-OZ	Oval profile escutcheon
M88S-RWSK	Bathroom turn indicator

Budapest Series

- Lever set with rose for interior doors thickness 32mm - 51mm (40mm with bathroom turn)
- Profile spindle 8mm
- Screw fixing

M191/88-RF Sprung lever on round rose

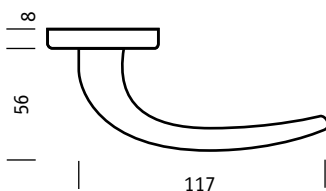
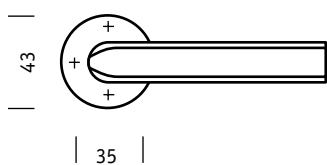











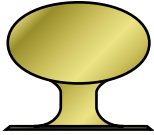









Escutcheons and Turns

M88S-OB	Lever key escutcheon
M88S-PZ	Euro profile escutcheon
M88S-OZ	Oval profile escutcheon
M88S-RWSK	Bathroom turn indicator

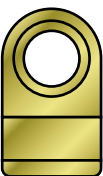
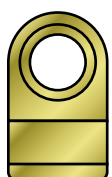

Accessories

<p>AR513 Georgian centre door knob</p> 	<p>AR514 Georgian mortice knob furniture</p> 	<p>AR515 Victorian mortice knob furniture</p> 
<p>AR516 Beaded centre door knob</p> 	<p>AR517 Beaded mortice knob furniture</p> 	<p>AR518 70mm x 300mm Georgian finger plate drilled and countersunk</p> 
<p>AR519 70mm x 300mm Victorian finger plate drilled and countersunk</p> 	<p>AR520 70mm x 300mm Shaped beaded finger plate drilled and countersunk</p> 	<p>AR521 75mm x 250mm (45mm x 190mm aperture) Georgian letter plate (sprung)</p> 
<p>AR522 75mm x 250mm (45mm x 190mm aperture) Victorian letter plate (sprung)</p> 	<p>AR523 75mm x 270mm (40mm x 210mm aperture) Shaped beaded letter plate (gravity)</p> 	<p>AR524 75mm X 270mm (40mm x 210mm aperture) Shaped letter plate (gravity)</p> 
<p>AR536 250mm letter tidy</p> 	<p>AR525 Georgian door knocker</p> 	<p>AR526 Victorian door knocker</p> 
<p>AR527 Beaded door knocker</p> 	<p>AR528 Georgian cylinder pull</p> 	<p>AR529 Victorian cylinder pull</p> 
<p>AR530 Beaded cylinder pull</p> 	<p>AR531 Single coat hook</p> 	<p>AR532 Double coat hook</p> 
<p>AR533 Hat & coat hook</p> 	<p>AR534 Heavy hat & coat hook</p> 	

Accessories

Accessories continued...

AR535

Door chain

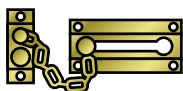

AR537A

63mm concealed fix door stop



AR537B

76mm concealed fix door stop



AR538A

63mm door stop face fix on rose



AR538B

76mm door stop face fix on rose



AR539A

Oval floor door stop



AR540

63mm numerals 0-9



AR541A

152mm victorian bow handle



AR541B

175mm georgian bow handle



AR548B

305mm cranked pull handle



AR542A

204mm victorian 2 pin casement stay



AR542B

254mm victorian 2 pin casement stay



AR542C

305mm victorian 2 pin casement stay



AR543A

Victorian casement fastener (wedge)



AR543B

Victorian casement fastener (hook & mortice)



AR549A

76mm cabin hook



AR549B

102mm cabin hook



AR549C

152mm cabin hook



AR549D

204mm cabin hook



AR549E

254mm cabin hook



AR549F

305mm cabin hook



ARRONE

Premium Lock Collection

Premium Lock Range

BS 3621 Security Locks

- Easily reversible brass latch bolt
- BS3621 : 1980
- Box striking plate to complement forend
- Suitable for bolt through fixing (38mm centres)
- Available keyed alike from our workshop - (max 6)
- 2 keyed
- Individually boxed complete with fixing screws

BS3621 5 Lever Mortice Sashlocks

AR-716-67-SC	67mm BS3621 5 lever mortice sashlock	SC
AR-716-67-PB	67mm BS3621 5 lever mortice sashlock	PB
AR-716-76-SC	76mm BS3621 5 lever mortice sashlock	SC
AR-716-76-PB	76mm BS3621 5 lever mortice sashlock	PB

Rebate Sets to Suit: BS3621 Mortice Sashlocks

ER-436-31	13mm Rebate set	BR
ER-436-51	13mm Rebate set	SC
ER-437-31	25mm Rebate set	BR
ER-437-51	25mm Rebate set	SC

BS 3621 5 Lever Mortice Deadlocks

AR-717-67-PB	67mm BS3621 5 lever mortice deadlock	PB
AR-717-67-SC	67mm BS3621 5 lever mortice deadlock	SC
AR-717-76-PB	76mm BS3621 5 lever mortice deadlock	PB
AR-717-76-SC	76mm BS3621 5 lever mortice deadlock	SC

Rebate Sets to Suit: BS3621 Mortice Deadlocks

ER-434-31	13mm Rebate set	BR
ER-434-51	13mm Rebate set	SC
ER-435-31	25mm Rebate set	BR
ER-435-51	25mm Rebate set	SC

5 Lever Key Blanks

AR-KB716	Key blanks (box quantity: 50)
-----------------	-------------------------------

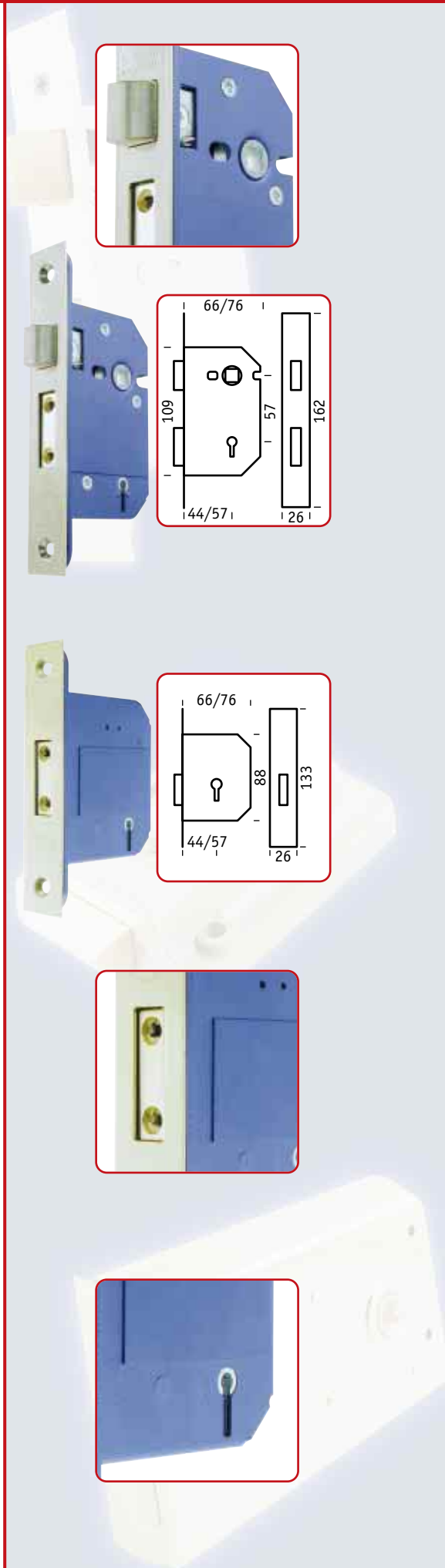

5 Lever Mortice Locks - Non BS

- Medium sprung
- Easily reversible brass latch bolt
- Suitable for bolt through furniture (38mm centres)
- Hardend steel rollers in deadbolt
- Box striking plate to complement forend
- 2 keyed
- 8mm follower on sashlock
- Hammered silver steel case
- Available keyed alike
- Individually boxed c/w fixing screws
- This range does not conform to BS 3621 : 1980

5 Lever Mortice Sashlocks

AR/M-714-63-BR	63mm 5 lever mortice sashlock	BR
AR/M-714-63-SC	63mm 5 lever mortice sashlock	SC
AR/M-714-75-BR	75mm 5 lever mortice sashlock	BR
AR/M-714-75-SC	75mm 5 lever mortice sashlock	SC

Rebate Sets to Suit: AR/M-714 Sashlocks

AR/M-729-13-BR	13mm Rebate set	BR
AR/M-729-13-SC	13mm Rebate set	SC
AR/M-729-25-BR	25mm Rebate set	BR
AR/M-729-25-SC	25mm Rebate set	SC

5 Lever Mortice Deadlocks

AR/M-715-63-BR	63mm 5 lever mortice deadlock	BR
AR/M-715-63-SC	63mm 5 lever mortice deadlock	SC
AR/M-715-75-BR	75mm 5 lever mortice deadlock	BR
AR/M-715-75-SC	75mm 5 lever mortice deadlock	SC

Rebate Sets to Suit: AR/M-715 Deadlocks

AR/M-730-13-BR	13mm Rebate set	BR
AR/M-730-13-SC	13mm Rebate set	SC
AR/M-730-25-BR	25mm Rebate set	BR
AR/M-730-25-SC	25mm Rebate set	SC

5 Lever Key Blanks

AR/M-5D-KB	Key blanks (box quantity: 50)
-------------------	-------------------------------

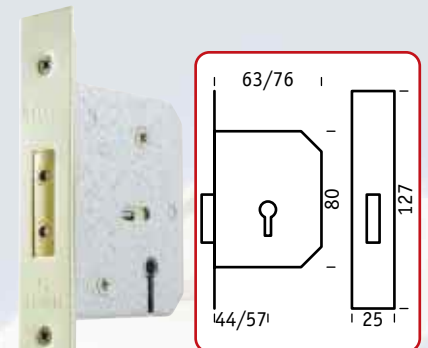
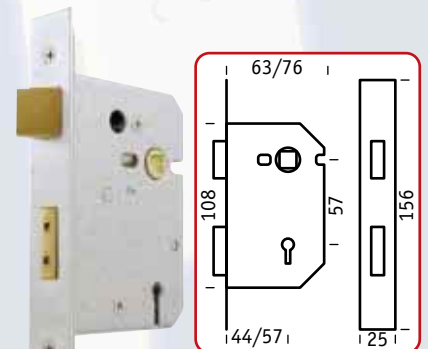

Premium Lock Range

3 Lever Mortice Locks

- Medium sprung
- Easily reversible brass latch bolt
- Suitable for bolt through furniture (38mm centres)
- Hardend steel rollers in deadbolt
- Available keyed alike from stock - (sashlocks & deadlocks keyed alike to same key differ)
- 2 keyed
- 8mm follower on sashlock
- Flat striking plate - to complement forend
- Hammered silver steel case
- 10 per box

3 Lever Mortice Sashlocks

- For keyed alike locks add KA to reference no. ie AR/M701-KA)

AR/M-701-63-BR	63mm 3 lever mortice sashlock	BR
AR/M-701-63-SC	63mm 3 lever mortice sashlock	SC
AR/M-701-75-BR	75mm 3 lever mortice sashlock	BR
AR/M-701-75-SC	75mm 3 lever mortice sashlock	SC

Rebate Sets to Suit: AR/M-701 Sashlocks

AR/M-729-13-BR	13mm Rebate set	BR
AR/M-729-13-SC	13mm Rebate set	SC
AR/M-729-25-BR	25mm Rebate set	BR
AR/M-729-25-SC	25mm Rebate set	SC

3 Lever Mortice Deadlocks

- For keyed alike locks add KA to reference no. ie AR/M702-KA)

AR/M-702-63-BR	63mm 3 lever mortice deadlock	BR
AR/M-702-63-SC	63mm 3 lever mortice deadlock	SC
AR/M-702-75-BR	75mm 3 lever mortice deadlock	BR
AR/M-702-75-SC	75mm 3 lever mortice deadlock	SC

Rebate Sets to Suit: AR/M-702 Deadlocks

AR/M-730-13-BR	13mm Rebate set	BR
AR/M-730-13-SC	13mm Rebate set	SC
AR/M-730-25-BR	25mm Rebate set	BR
AR/M-730-25-SC	25mm Rebate set	SC

3 Lever Key Blanks

AR/M-3D-KB	Key blanks (box quantity: 50)
-------------------	-------------------------------

Bathroom Locks

- 5mm Snib follower
- Same case size as Commercial range 3 lever and cylinder lock cases

AR/M-723-63-BR	63mm Bathroom lock	BR
AR/M-723-63-SC	63mm Bathroom lock	SC
AR/M-723-75-BR	75mm Bathroom lock	BR
AR/M-723-75-SC	75mm Bathroom lock	SC

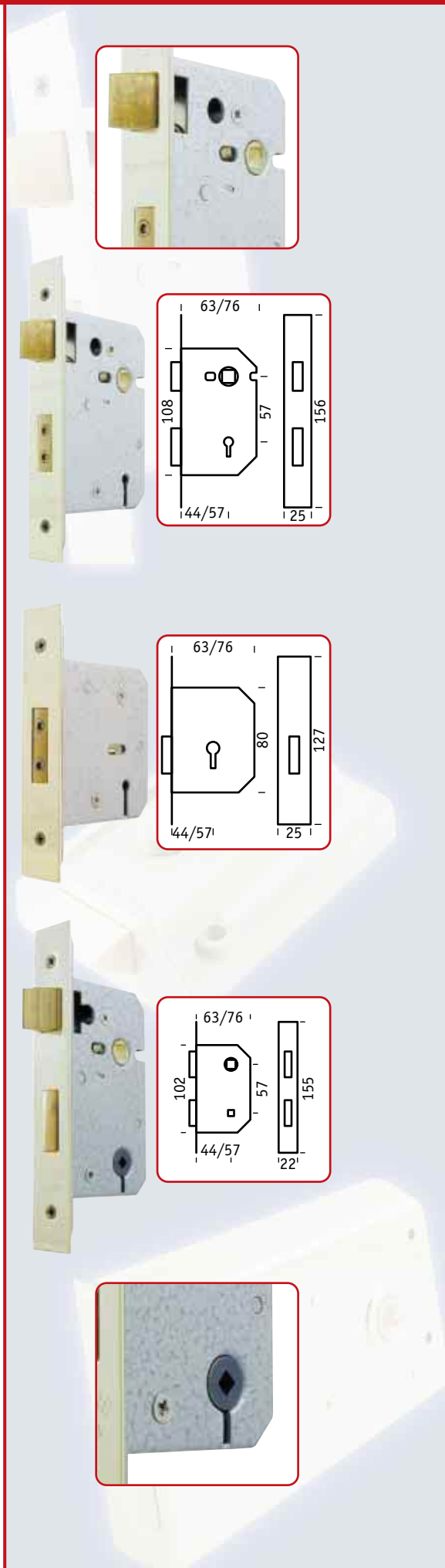

Nightlatches & Rim Cylinders

- A small range of cylinder rim nightlatches, elegant in design and finish

Traditional Cylinder Rim Nightlatches

AR/M-735-BR	Traditional cylinder rim nightlatch 2 keyed 90mm case / 60mm backset	CPG/BR
AR/M-735LC	Traditional nightlatch case only 90mm case / 60mm backset	CPG

Standard Deadlocking Cylinder Rim Nightlatches

AR/M-740-BR	Standard deadlocking cylinder rim nightlatch 2 keyed 90mm case / 60mm backset	SE/BR
AR/M-740-SC	Standard deadlocking cylinder rim nightlatch 2 keyed 90mm case / 60mm backset	SE/SC
AR/M-740-BR/BR	Standard deadlocking cylinder rim nightlatch 2 keyed 90mm case / 60mm backset	BR/BR

Standard Deadlocking Nightlatch Cases Only

AR/M-740LC-SE	Standard deadlocking nightlatch case 90mm case / 60mm backset	SE
AR/M-740LC-BR	Standard deadlocking nightlatch case 90mm case / 60mm backset	BR

Narrow Style Deadlocking Cylinder Rim Nightlatches

AR/M-745-BR	Narrow style deadlocking cylinder rim nightlatch 2 keyed 60mm case / 40mm backset	SE/BR
AR/M-745-SC	Narrow style deadlocking cylinder rim nightlatch 2 keyed 60mm case / 40mm backset	SE/SC
AR/M-745-BR/BR	Narrow style deadlocking cylinder rim nightlatch 2 keyed 60mm case / 40mm backset	BR/BR

Narrow Style Deadlocking Nightlatch Cases Only

AR/M-745LC-SE	Narrow style deadlocking nightlatch case 60mm case / 40mm backset	SE
AR/M-745LC-BR	Narrow style deadlocking nightlatch case 60mm case / 40mm backset	BR

Rim Cylinders

AR/M-770-BR	Rim cylinder 2 keyed	BR
AR/M-770-SC	Rim cylinder 2 keyed	SC
AR/M-770-BR-KA	Rim cylinder keyed alike 2 keyed	BR
AR/M-770-SC-KA	Rim cylinder keyed alike 2 keyed	SC

Key Blanks

AR/M-KB-770	5 pin cylinder key blank
--------------------	--------------------------



Premium Lock Range

Contract Range

- Light duty locks suitable only for internal domestic applications
- Not suitable for unsprung door furniture

3 Lever Mortice Sashlock (Light Cases, 2 Keyed)

AR/M-172-63-BR	63mm Light case 3 lever mortice sashlock (2 keyed)	EB
AR/M-172-63-NP	63mm Light case 3 lever mortice sashlock (2 keyed)	NP
AR/M-172-75-BR	75mm Light case 3 lever mortice sashlock (2 keyed)	EB
AR/M-172-75-NP	75mm Light case 3 lever mortice sashlock (2 keyed)	NP

Bathroom Locks (5mm Snib Follower)

AR/M-173-63-BR	63mm Bathroom lock (5mm snib follower)	EB
AR/M-173-63-NP	63mm Bathroom lock (5mm snib follower)	NP
AR/M-173-75-BR	75mm Bathroom lock (5mm snib follower)	EB
AR/M-173-75-NP	75mm Bathroom lock (5mm snib follower)	NP

Key Blanks to Suit 3 Lever Sashlocks

AR/M-3L-LH-KB	Left hand key blank
AR/M-3L-RH-KB	Right hand key blank

Tubular Mortice Latch

AR/M-719-63-BR	63mm Tubular mortice latch	BR
AR/M-719-63-NP	63mm Tubular mortice latch	NP
AR/M-719-75-BR	75mm Tubular mortice latch	BR
AR/M-719-75-NP	75mm Tubular mortice latch	NP

Rim Locks

- Premier rim locks suitable for many applications

Double Handed Rim Locks (2 keyed)

AR/M-725-BL	150x100mm Double handed rim lock (box quantity: 10)	BL
AR/M-725-BR	150x100mm Double handed rim lock (box quantity: 1)	BR
AR/M-726-BL	138x75mm Double handed rim lock (box quantity: 10)	BL
AR/M-726-BR	138x75mm Double handed rim lock (box quantity: 1)	BR

Double Handed Rim Deadlocks (2 keyed)

AR/M-727-BL	100x75mm Double handed rim deadlock (box quantity: 10)	BL
AR/M-727-BR	100x75mm Double handed rim deadlock (box quantity: 1)	BR

Rim Latch

AR/M-728-BL	100x75mm Rim latch (box quantity: 10)	BL
AR/M-728-BR	100x75mm Rim latch (box quantity: 1)	BR

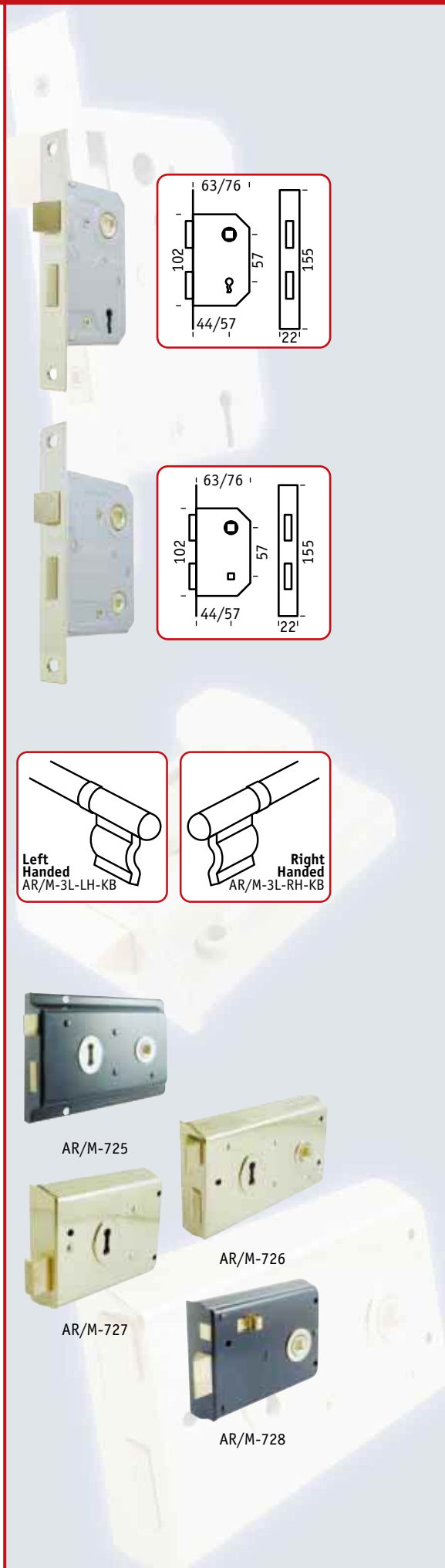

Fire d/o
skreen
shim

Fire Signs

Fire Signs

Architectural Signs

Screen printed. Available in (please state suffix when specifying):

- Satin stainless steel - SSS
- Polished stainless steel - PSS
- Polished brass - PB
- Satin anodised aluminium - SAA

AR900 ø75mm		AR901 ø75mm		AR902 ø75mm	
AR904 80mm x 80mm		AR905 80mm x 80mm		AR906 80mm x 80mm	
AR907 80mm x 80mm					

Fire Signs

Available in (please state suffix when specifying):

- Enamelled aluminium (screw fixing) - EA
- Rigid plastic (screw fixing) - RP
- Vinyl self adhesive - VS

80mm x 80mm Signs

AR916A 80mm x 80mm		AR916B 80mm x 80mm		AR916C 80mm x 80mm	
AR916D 80mm x 80mm		AR916E 80mm x 80mm		AR916F 80mm x 80mm	
AR916M 80mm x 80mm		AR916N 80mm x 80mm			

200mm x 200mm Signs

AR916P 200mm x 200mm		AR916Q 200mm x 200mm		AR916S 200mm x 200mm	
AR916T 200mm x 200mm		AR916U 200mm x 200mm			

Fire Signs

Screen printed. Available in (please state suffix when specifying):

- Enamelled aluminium (screw fixing) - EA
- Rigid plastic (screw fixing) - RP
- Vinyl self adhesive - VS

AR917A 600mm x 200mm



AR917B 600mm x 200mm



AR917C 600mm x 200mm



AR917D 600mm x 200mm



AR917E 600mm x 200mm



AR917F 600mm x 200mm



AR917G 600mm x 200mm



AR917H 600mm x 200mm



AR917I 600mm x 200mm



AR917J 600mm x 200mm



AR918A 450mm x 100mm

AR918AC 900mm x 150mm



AR918B 600mm x 100mm

AR918BB 850mm x 125mm



AR918C 500mm x 100mm



AR918D 350mm x 100mm

AR918DB 550mm x 125mm

AR918DC 685mm x 150mm



AR918E 600mm x 100mm

AR918EB 850mm x 125mm



AR919A 400mm x 200mm



AR919B 400mm x 200mm



AR919C 450mm x 200mm

AR919CB 685mm x 250mm



AR919D 300mm x 100mm

AR919DB 450mm x 150mm



AR919E 450mm x 200mm



AR919F 400mm x 200mm



Fire Signs

Fire Signs continued...

AR920B 300mm x 70mm

AR920BB 600mm x 100mm

Push bar to open

AR920C 300mm x 100mm

Push to open

AR920D 450mm x 150mm



AR920E 450mm x 150mm



AR921A
200mm x 200mm



AR921B
200mm x 200mm

FIRE
EXIT

AR921C
100mm x 100mm

AR921CB
150mm x 150mm

AR921CC
200mm x 200mm



AR921D
100mm x 150mm



Conditions of Sale

1. INTERPRETATION

1.1 In these conditions:

BUYER	means the person, firm or company specified overleaf entering into the Contract as customer to purchase the Goods from the Seller;
CONDITIONS	means the standard terms and conditions of sale set out in this document and (unless the context otherwise requires) includes those terms set out overleaf and any special terms and conditions agreed in writing between the Buyer and the Seller;
CONTRACT	means the contract for the purchase and sale of the Goods;
GOODS	means the goods specified overleaf (including any installment of the Goods or any parts for them) which the Seller is to supply in accordance with these Conditions;
SELLER	means Hoppe (UK) Limited (registered in England under number 2286568);
WRITING	includes facsimile transmission and comparable means of communication.

1.2 Any reference in these Conditions to any provision of a statute shall be construed as a reference to that provision as amended, re-enacted or extended at the relevant time.

1.3 The headings in these Conditions are for convenience only and shall not affect their interpretation.

2. BASIS OF THE SALE

2.1 The Seller shall sell and the Buyer shall purchase the Goods in accordance with any written quotation of the Seller which is accepted by the Buyer or any written order of the Buyer which is accepted by the Seller, subject in either case to these Conditions which shall govern the Contract to the exclusion of any other terms and conditions subject to which any such quotation is accepted or purported to be accepted or any such order is made or purported to be made by the Buyer.

2.2 The Seller's employees or agents are not authorised to make any representations concerning the Goods unless confirmed by the Seller in Writing. In entering into the Contract the Buyer acknowledges that it does not rely on, and waives any claim for breach of any such representations which are not so confirmed. No variation to these Conditions shall be binding unless agreed in Writing between the Buyer and the Seller.

2.3 Any advice or recommendation given by the Seller or its employees or agents to the Buyer or its employees or agents relating to the Goods which is not confirmed in Writing by the Seller is followed or acted upon entirely at the Buyer's own risk, and accordingly the Seller shall not be liable for any such advice or recommendation which is not so confirmed.

2.4 Any typographical, clerical or other error or omission in any sales or other document or information issued by the Seller shall be subject to correction without any liability on the part of the Seller.

3. ORDERS AND SPECIFICATIONS

3.1 The Buyer shall be responsible to the Seller for ensuring the accuracy of the terms of any order submitted by the Buyer and for giving the Seller any necessary information relating to the Goods within a sufficient time to enable the Seller to perform the Contract in accordance with its terms.

3.2 The quantity, and description of the Goods shall be those set out in the Seller's quotation (if accepted by the Buyer) or the Buyer's order (if accepted by the Seller).

3.3 No order which has been accepted by the Seller may be cancelled by the Buyer except with the agreement in Writing of the Seller and on terms that the Buyer shall indemnify the Seller in full against all loss (including loss of profit), costs (including the cost of all labour and materials used) damages, charges and expenses incurred by the Seller as a result of cancellation.

3.4 If the Goods are to be manufactured or any process is to be applied to the Goods by the Seller in accordance with a specification submitted by the Buyer, the Buyer shall indemnify the Seller against all loss, damages, costs and expenses awarded against or incurred by the Seller in connection with or paid or agreed to be paid by the Seller in settlement of any claim for infringement of any patent, copyright, design, trade mark or other industrial or intellectual property rights of any other person which results from the Seller's use of the Buyer's specification.

3.5 All drawings, illustrations, descriptions and specifications in the Seller's catalogues, price list and other advertising material (including CD ROM) are intended to give no more than a general idea of the goods manufactured and/or distributed by the Seller and such information is not intended and shall not be relied upon as giving a precise description of any goods nor as being representative as to any matter contained therein, nor shall any of it form part of any Contract with the Buyer.

4. PRICE OF THE GOODS

4.1 The price of the Goods shall be the price set out in the Seller's quotation (if accepted by the Buyer) or the Buyer's order (if accepted by the Seller).

4.2 The Seller reserves the right, by giving notice to the Buyer at any time before delivery, to increase the price of the Goods to reflect any increase in the cost to the Seller which is due to any factor beyond the control of the Seller (such as, without limitation, any foreign exchange fluctuation, currency regulation, alteration of

duties, increase in suppliers' prices, any change in delivery dates, or any delay caused by any instructions of the Buyer or failure of the Buyer to give the Seller adequate information or instructions.

4.3 The price is exclusive of any applicable value added tax, which the Buyer shall be additionally liable to pay to the Seller.

4.4 List prices are subject to alteration without notice and all orders are accepted on condition that they are charged at prices ruling at time of despatch, save that the Buyer will be entitled to cancel the order for the goods if the increase in price exceeds 5% of the price originally quoted.

4.5 Carriage charges and cost of delivery will be charged in accordance with the Seller's normal practice stated in its current price list.

5. TERMS OF PAYMENT

5.1 Subject to any special terms agreed in Writing between the Buyer and the Seller, the Seller shall be entitled to invoice the Buyer for the price of the Goods on or at any time after delivery of the Goods, unless the Goods are to be collected by the Buyer or the Buyer wrongfully fails to take delivery of the Goods, in which event the Seller shall be entitled to invoice the Buyer for the price at any time after the Seller has notified the Buyer that the Goods are ready for collection or, as the case may be, the Seller has tendered delivery of the Goods.

5.2 The Buyer shall pay the price of the Goods within 30 days of the date of the Seller's invoice and the Seller shall be entitled to recover the price, notwithstanding that delivery may not have taken place and the property in the Goods has not passed to the Buyer. The time of payment of the price shall be of the essence of the Contract.

5.3 If the Buyer fails to make any payment on the due date then, without prejudice to any other right or remedy available to the Seller, the Seller shall be entitled to:

5.3.1 suspend all or any further deliveries to the Buyer made under that or any other contract with the Buyer and in such event the Buyer shall not be released from its obligations to the Seller under that or any other contract or cancel the Contract or any other contract with the Buyer and to claim damages from the Buyer for breach of contract;

5.3.2 appropriate any payment made by the Buyer to such of the Goods (or the goods supplied under any other contract between the Buyer and the Seller) as the Seller may think fit (notwithstanding any purported appropriation by the Buyer); and

5.3.3 charge the Buyer interest (both before and after any judgement) on the amount unpaid, at the rate of 4 per cent per annum above Barclays Bank base rate from time to time accruing daily, until payment in full is made.

5.4 The Seller may without notice set off any sums from time to time owed to the Buyer in or towards the satisfaction of all and any liabilities of the Buyer to the Seller whether or not under this Contract.

5.5 The Buyer shall not be entitled to deduct or set-off from any sum due under the Contract for loss or expense alleged to have been incurred by the Buyer by any reason of any breach or failure to observe the provisions of any Contract made between the Buyer and the Seller. The Buyer expressly waives and abandons its common law and/or equitable right to set-off which the Buyer might otherwise be entitled.

6. DELIVERY

6.1 Delivery will be deemed to have taken place:

(a) In the case of carriage arranged by the Seller, when goods are physically delivered to the location point specified in writing by the Buyer in its order form and which delivery location point has been agreed by the Seller.

(b) In the case of carriage arranged by the Buyer, when the goods are loaded onto the Buyer's vehicle or are physically delivered to the Buyer's carrier.

6.2 Any dates quoted in the Seller's quotation (if accepted by the Buyer) or the Buyer's order (if accepted by the Seller) for delivery of the Goods are approximate only and the Seller shall not be liable for any delay howsoever caused. Time for delivery shall not be of the essence unless previously agreed in Writing. The Goods may be delivered by the Seller in advance of the quoted delivery date upon giving reasonable notice to the Buyer.

6.3 Where the Goods are to be delivered in installments, each delivery shall constitute a separate contract and failure by the Seller to deliver any one or more of the installments in accordance with these Conditions or any claim by the Buyer in respect of any one or more installments shall not entitle the Buyer to treat the Contract as a whole as repudiated.

6.4 If the Seller fails to deliver the Goods (or any installment) for any reason other than any cause beyond the Seller's reasonable control or the Buyer's fault, and the Seller is accordingly liable to the Buyer, the Seller's liability shall be limited to the excess, if any, of the cost to the Buyer (in the cheapest available market) of similar goods to replace those not delivered over the price of the Goods.

6.5 If the Buyer fails to take delivery of the Goods or fails to give the Seller adequate delivery instructions at the time stated for delivery (otherwise than by reason of any cause beyond the Buyer's reasonable control or by reason of the Seller's fault) then, without prejudice to any other right or remedy available to the Seller, the Seller may:

- 6.5.1 store the Goods until actual delivery and charge the Buyer for the reasonable cost of storage, including insurance; or
- 6.5.2 sell the Goods at the best price readily obtainable and, after deducting all reasonable storage and selling expenses, account to the Buyer for the excess over the price under the Contract or charge the Buyer for any shortfall below the price under the Contract.

7. RISK AND PROPERTY

- 7.1 Risk of damage to or loss of the Goods shall pass to the Buyer:
 - 7.1.1 in the case of Goods to be delivered at the Seller's premises, at the time when the Seller notifies the Buyer that the Goods are available for collection;
 - 7.1.2 in the case of Goods to be delivered otherwise than at the Seller's premises, at the time of delivery or, if the Buyer wrongfully fails to take delivery of the Goods, the time when the Seller has tendered delivery of the Goods;
 - 7.1.3 the seller shall not be liable for a claim in respect of damage to Goods in transit unless such claim is notified to the carrier of the Goods on delivery or if that is not practical to the seller in writing within 3 days of delivery;
 - 7.1.4 the Buyer should ensure that he has adequate insurance from the time at which risk passes to him.
- 7.2 Notwithstanding delivery and the passing of risk in the Goods, or any other provision of these Conditions, the property in the Goods shall not pass to the Buyer until the Seller has received in cash or cleared funds payment in full of the price of the Goods and all other goods sold or agreed to be sold by the Seller to the Buyer under any other contract.
- 7.3 Until such time as the property in the Goods passes to the Buyer, the Buyer shall hold the Goods as the Seller's agent or bailee, and shall keep the Goods separate from those of the Buyer and third parties and properly stored, protected and insured and identified as the Seller's property. Until that time the Buyer shall be entitled to use the Goods in the ordinary course of its business, but shall have a fiduciary duty to the Seller to account for the proceeds of sale or otherwise of the Goods, whether tangible or intangible, including insurance proceeds, and shall keep all such proceeds separate from any monies or property of the Buyer and third parties and, in the case of tangible proceeds, properly stored, protected and insured.
- 7.4 Until such time as the property in the Goods passes to the Buyer (and provided the Goods are still in existence and have not been re-sold), the Seller shall be entitled at any time to require the Buyer to deliver up the Goods to the Seller and, if the Buyer fails to do so forthwith, to enter upon any premises of the Buyer or any third party where the Goods are stored and repossess the Goods and for that purpose the Buyer hereby authorises and licences the Seller, its officers, employees and agents to enter upon any land or building upon which the Goods are situated to recover those Goods.
- 7.5 The Buyer shall not be entitled to or in any way charge by way of security for any indebtedness any of the Goods which remain the property of the Seller, but if the Buyer does so all moneys owing by the Buyer to the Seller shall, without prejudice to any other right or remedy of the Seller, forthwith become due and payable.
- 7.6 Where Goods are exported from the United Kingdom the following provisions of this sub-clause shall apply to the Contract in substitution for the appropriate provisions of the remainder of clause 7 hereof. Goods for export will unless otherwise agreed be delivered FOB to a United Kingdom port nominated by the Buyer or selected by the Seller. The risks in goods sold on FOB terms shall pass when they cross at the ships rail at port of loading.

8. WARRANTIES AND LIABILITIES

- 8.1 Subject to the conditions set out below the Seller warrants that the Goods will correspond with their specification at the time of delivery and will be free from defects in material and workmanship for a period of 12 months from the date of their initial use or 12 months from delivery whichever is the first to expire.
- 8.2 The Seller warrants that the Goods will at the time of delivery correspond with the description specified in the Seller's quotation (if accepted by the Buyer) or the Buyer's order (if accepted by the Seller).
- 8.3 Any claim by the Buyer which is based on any defect in the quality or condition of the Goods or their failure to correspond with description shall, whether or not delivery is refused by the Buyer, be notified to the Seller within 7 days from the date of delivery or, where the defect or failure was not apparent on reasonable inspection, within a reasonable time after discovery of the defect or failure. If delivery is not refused, and the Buyer does not notify the Seller in accordance with this Condition, the Buyer shall not be entitled to reject the Goods and the Seller shall have no liability for such defect or failure, and the Buyer shall be bound to pay the price as if the Goods had been delivered in accordance with the Contract.
- 8.4 Where any valid claim in respect of any of the Goods which is based on any defect in the quality or condition of the Goods or their failure to meet description is notified to the Seller in accordance with these Conditions, the Seller shall be entitled to replace the Goods (or the part in question) free of charge or, at the Seller's sole discretion, refund to the Buyer the price of the Goods (or a proportionate part of the price) but the Seller shall have no further liability to the Buyer.

- 8.5 Except in respect of death or personal injury caused by the Seller's negligence, the Seller shall not be liable to the Buyer by reason of any representation, or any implied warranty, condition or other term, or any duty at common law, or under the express terms of the Contract, for any consequential loss or damage (whether for loss of profit or otherwise), costs, expenses or other claims for compensation whatsoever (whether caused by the negligence of the Seller, its employees or agents or otherwise) which arise out of or in connection with the supply of the Goods or their use or resale by the Buyer and the entire liability of the Seller under or in connection with the Contract shall not exceed the price of the Goods, except as expressly provided in these Conditions.

- 8.6 The Seller shall not be liable to the Buyer or be deemed to be in breach of the Contract by reason of any delay in performing, or any failure to perform, any of the Seller's obligations in relation to the Goods, if the delay or failure was due to any cause beyond the Seller's reasonable control. Without prejudice to the generality of the foregoing, causes beyond the Seller's reasonable control shall include act of God, explosion, flood, tempest, fire or accident, war or threat of war, sabotage, insurrection, civil disturbance or requisition, acts, restrictions, regulations, bye-laws, prohibitions or measures of any kind on the part of any governmental, parliamentary or local authority, import or export regulations or embargoes, strikes, lock-outs or other industrial actions or trade disputes (whether involving employees of the Seller or of a third party), difficulties in obtaining raw materials, labour, fuel, parts or machinery, power failure or breakdown in machinery.

- 8.7 The Seller will in no circumstances unless expressly agreed in writing accept the return of any Goods sold to the Buyer. All requests for the return of Goods must be made in writing to the Seller. Providing the Goods were those specified by the Buyer at time of order the Seller shall authorise return of Goods at their complete discretion and shall charge a minimum handling charge of £15 and minimum restocking charge of 25%.

9. INSOLVENCY OF BUYER

- 9.1 This clause applies if:
 - 9.1.1 the Buyer makes any voluntary arrangement with its creditors or becomes subject to an administration order (or being an individual or firm) becomes bankrupt or (being a company) goes into liquidation, otherwise than for the purpose of amalgamation or reconstruction; or
 - 9.1.2 an encumbrancer takes possession, or a receiver is appointed, of the Buyer's undertaking or any of its property or assets; or
 - 9.1.3 the Buyer ceases, or threatens to cease, to carry on business; or
 - 9.1.4 the Seller reasonably apprehends that any of the events mentioned above is about to occur in relation to the Buyer and notifies the Buyer accordingly.
- 9.2 If this clause applies then, without prejudice to any other right or remedy available to the Seller, the Seller shall be entitled to cancel the Contract or suspend any further deliveries under the Contract without any liability to the Buyer, and if the Goods have been delivered, but not paid for, the price shall become immediately due and payable notwithstanding any previous agreement or arrangement to the contrary.

10. GENERAL

- 10.1 Neither the Buyer nor the Seller shall be entitled to assign the whole or any part of its rights and/or obligations under the Contract without the prior written consent of the other.
- 10.2 Any notice required or permitted to be given by either party to the other under these Conditions shall be in Writing addressed to that other party at its registered office or principal place of business or such other address as may at the relevant time have been notified pursuant to this provision to the party giving the notice. A notice shall be deemed to have been received, in the case of a facsimile, upon transmission and, in the case of a letter, forty eight hours after posting. In proving service by letter, it shall be sufficient to show that the envelope containing the notice was properly addressed and stamped and duly posted.
- 10.3 No waiver by the Seller of any breach of the Contract by the Buyer shall be considered as a waiver of any subsequent breach of the same or any other provision.
- 10.4 If any provision of these Conditions is held by any competent authority to be invalid or unenforceable in whole or in part the validity of the other provisions of these Conditions and the remainder of the provision in question shall not be affected thereby unless such provision goes to the root of the Contract.
- 10.5 The Conditions shall constitute the entire agreement in relation to the sale of the Goods and no modification or waiver thereof shall be valid unless made in Writing expressly for the purpose and signed by an authorised officer of the Seller and of the Buyer.
- 10.6 The Contract shall be governed by the laws of England and the Buyer agrees to submit to the non-exclusive jurisdiction of the English courts.

HOPPE (UK) LTD
(Charter Hardware Division)

Gailey Park, Gravelly Way, Standeford, Wolverhampton, WV10 7GW

Telephone: 01902 484400 **Fax:** 01902 484406 **Sales Direct:** 01902 484410/20/30

E-mail: info.uk@hoppe.com **Website:** <http://www.hoppe.com>

MARCH 2000